

The secret life of cars  
and what they reveal about us



# The secret life of cars and what they reveal about us

Written by Richard Benson, Dr Iain MacRury and Dr Peter Marsh

A report by **BMW**

Editor-in-chief – Richard Benson

Academic research – Professor Andrew Blake, Simon Bradley, Dr Peter Collett, Dr Iain MacRury, Dr Peter Marsh, Emma Roberts

Managing editor – Nina Whitby

Deputy editor – Laura St Quinton

Contributors – Kevin Braddock, Tamara Fletcher, Dan Johnson, David Mattin

Sub editor – Lucy Hyslop

Design – Fibre

Illustrations – Raymond Biesinger, Nick Brooker, Connie Lovett, Jamie Sneddon

Cover photography – Mike Dmochowski

Photography – Christopher Beech, Tim Crocker, Marek Vogel, Matthias Ziegler

#### Acknowledgements

Thanks to all participants in the focus groups and observations (who must remain anonymous, but whose openness and insight is greatly appreciated), and also to the many respondents who gave interviews. Your ideas and experiences enriched the progress and the output of the project.

#### Also thanks to:

Awad Bhenick, David Blake, Nida Blake, Rob Conkie, Gareth Coombs, Tim Crocker, Mark Farago, Sarah Goode, Paul Gormley, Gavin Jaunky, Gareth Lewis, Sally Luxemburg, Kiran Moolgavkar, Jamie Robertson, Alasdair Spark, Vanda Varga, Ben Vincent, Kay Vincent.

First devised and published in the United Kingdom in 2007  
by Not Actual Size, 8 Playhouse Court, 62 Southwark Bridge  
Road, London, SE1 0AT on behalf of BMW (UK) Ltd.

[www.notactualsize.co.uk](http://www.notactualsize.co.uk)

BMW (UK) Ltd © 2007

The contents of this book are believed correct at the time of  
printing. Nevertheless the publisher can accept no responsibility  
for errors or changes in, or omissions from, the details given.

ISBN 0-95561411-8

All Rights Reserved. No part of this publication may be reproduced  
or transmitted in any form or by any means, electronic or  
mechanical, including photocopy, recording or any other  
information storage and retrieval system, without prior permission  
in writing from the publisher.

# Contents

3	<a href="#">BMW Introduction</a>
4	<a href="#">Editorial Team Introduction</a>
6	<a href="#">Chapter 1: The pleasure principle</a> Why driving makes us happy – secrets of the somatomorphists – how BMW cars emotionally engage you – the hidden geniuses of the Projekthaus – love at first drive – reinventing cars for the 21st Century
16	<a href="#">Chapter 2: The homing instinct</a> The peculiarities of personalisation – why being annoyed when someone else messes up your car is perfectly natural – the cupholder principle – how we build bonds – BMW's understanding of detail in personal spaces – why a BMW is like a tailored suit – making cars 'sing'
28	<a href="#">Chapter 3: Sign of the times</a> Now the car is yours, share it with the world – co-operation, collaboration, and the hitherto unclaimed language of driving – a society on the move – understanding how driving really is – the difficult question of letting people out at junctions – when the going gets tough, BMW engineers get you going
42	<a href="#">Chapter 4: Work, rest and play</a> The car as a psychological space – satellite navigation secrets and BMW's vision for the future – some rather nice ways in which relationships can change in cars – why no one wants to sit behind dad – cars as places of joy – how BMW are working to make cars that meet these demands – BMW cars and weddings – BMW soothes those stressful situations
56	<a href="#">Chapter 5: You and yours</a> What your car says about you – the new rules for car brands – an anthropomorphic investigation into the rituals of car care – BMW's vision for customisation in the future – how a small key can keep you in mind – the user-generated, personalised BMW is coming – the ritual of car washes – wiki-economies
66	<a href="#">Epilogue</a>
70	<a href="#">Methodology</a>
74	<a href="#">Glossary</a>
76	<a href="#">Appendix</a>

## BMW introduction

Picture, if you will, an everyday scene from contemporary life. You are about to drive off on holiday with your family. Everyone and everything is fully loaded, and you have just locked the front door. You turn and see the car, clean, striking and somehow full of promise. Then, with a smile, you walk towards it, get in behind the wheel, slip in the memory key and start the ignition. There is the familiar reassuring sound of the engine, the comforting feel of the seat and controls, the discernible sense of happy anticipation in the car as you pull away.

Little moments of joy; in life we often talk about the big, momentous occasions, but looking back, it's often little flashes of pleasure that we remember.

For BMW's designers and engineers, such moments are key parts of what cars are all about. The company philosophy is to deliver unadulterated driving pleasure through 'The Ultimate Driving Machine', and that pleasure is not confined to cruising motorways or putting the car through its paces on a twisting mountain road, but inclusive of all driving experiences, from living with your car every day to setting off on holiday with your loved ones. For BMW, driving pleasure is a question of detail, ergonomics, stimulation of the senses at all times; it is a question of how the car makes you feel.

The company, still independently owned, has a long history of innovating in order to improve the driver's experience and maintain the uniqueness of the BMW 'feel'. In order to sustain this rate of innovations, the company has developed an unparalleled understanding of what it is to be a driver, studying and researching not only pleasure, but all relevant behaviour, emotion, communication and sensibility. The resulting body of knowledge can offer some interesting insights into our lives in these early years of the 21st Century, and this report, commissioned specifically to explore how it feels to drive in contemporary Britain, is a case in point. BMW offers it to the public in the hope that it might entertain, inform, and perhaps cast some light on our driving habits!

There is no doubt that cars and driving are going through re-evaluations, and are headed for some major changes in the coming years. This process will be challenging and interesting, and BMW is committed to an innovative and proactive role in maintaining a pleasurable future for car drivers.



Jim O'Donnell  
Managing Director  
BMW (UK) Ltd

## Introduction

"Technology cannot be an end in itself. Foremost in our minds must be the experience that the driver wants to have. In this respect, our engineers are now really engineers of human experience."

Dr Frank Althoff, BMW Driver Interfaces Management

In his seminal 2003 book *Emotional Design: Why We Love (Or Hate) Everyday Things*<sup>1</sup>, the American cognitive scientist Don Norman sets out to show the reader that attractive objects tend to be more effective than unattractive ones simply because they make the person using them feel better. Referencing everything from teapots to ATM keypads, Norman demonstrates that aesthetically pleasing things make users feel happier and more positive, and that users who feel happy and positive find it easier to find solutions to problems.

Because the iPod's casing and interface were simple and beautiful, for example, new users were willing to spend more time exploring and making mistakes than they were when confronted with uglier old MP3 players. The same is true of a Dyson vacuum cleaner, Frank Gehry's Guggenheim Museum in Bilbao, or Philippe Starck's orange squeezer; beauty does not just have to be an aesthetic 'extra' – it helps get results. If, Norman argues, designers take human actions and emotions as their starting point, then the objects they design will have this magical coalescence of attractiveness and efficacy. What makes us happier works better, and vice versa.

As is often the case with true genius, the brilliance of Norman's observation lies less in grasping a hidden, complex truth than in articulating a hitherto unarticulated truth that we all immediately recognise. Many designers and analysts of human behaviour have been instinctively working with these basic assumptions for some time, and as consumers we have come to expect usability and good feeling from the objects we use, and the things we experience. We like the intuitive easiness of the Nokia wireless phone interface, understand the material and psychological benefits of good landmark art projects, and appreciate the design in a good pair of running shoes. There is underway a paradigm shift in the way we see design; it is not, as is sometimes suggested, a question of learning to appreciate beautiful forms, but rather one of understanding how beauty, form, function, pleasure and effectiveness can come together.

As an innovative and dynamic car manufacturer, BMW has to understand these developments, since they help to determine the demands that people make of their cars now and in the future. Cars may have been initially conceived to enable mobility, but having been subjected to decades of improvement in terms of reliability, speed, performance and style, they must now deliver against vastly increased expectations of comfort and usability.

BMW has a long history of focusing its design on pleasure. Freude am Fahren – pure driving pleasure – was adopted as a philosophy way back in 1965. Given the company's preoccupation with the relationship between driver and car, one might say that BMW was practising emotional design decades ago; and for years the company's independence has allowed it to explore radical new possibilities designed to increase driving pleasure.

So it is perhaps to be expected that the company has been at the vanguard of this new movement. "We want our cars to speak to people on an emotional level," Chris Bangle, BMW Group Design Director, has said. "Even the word 'car' is emotional. An auto-mobile is just a horizontal elevator; a car is much more. The difference is between what we use, and what we are." For BMW, design goes far beyond a look.

In order to develop innovations such as iDrive and gesture recognition, and to plan for the long-term future, BMW has undertaken long and close studies of all human behaviour pertaining to cars and driving. Its researchers have studied the emotional and physical aspects of travelling by car: the intimate, personal feelings arising from our personal relationships with our cars; our relationship with other road users; and the car's role in our culture.

The findings often offer interesting insights into contemporary life; because driving is such an intimate, individual experience, and yet also so widespread. It is a lens through which we can view individual feelings, and society as a whole. Social change affects car design; car design can encourage social change. The long commutes now routinely undertaken would have been far less pleasant to drivers of cars in, say, the 1950s. Alongside the growing popularity of adrenaline sports such as snowboarding and mountain biking we've seen an increase in the demand for MPVs, SUVs and Tourers – cars designed to provide a sense of freedom and adventure.

For reasons which will be explored within this report, drivers' relationships with their cars are becoming more complex and multi-dimensional. All of our lives have become less predictable, less routine-based, and more adventurous; and of course we generally travel far greater distances than we did 20 years ago. Cars have met both new demands created by these changes, and helped to push them along – and are thus intimately connected to our new mobile, 21st-Century lives. Moreover, as technologically enhanced interactivity is making the engagement between car and driver both more subtle and deep-seated, the way in which it is used reveals interesting and hitherto unexplored facets of human behaviour – as the report shows, a simple navigation system can offer manifold insights into the psyche of the male and female driver.

In seeking to understand drivers, and to anticipate their future needs and desires, then, BMW enters into a set of dialogues with contemporary culture, dialogues that touch on many and various topical themes. This report aims to share some of our dialogues and insights, using them to show how the company's designers are responding with emotional and user-based design. Drawing on academic analysis, driver interviews, social observation and interviews with BMW experts, we hope to show how BMW is building on its understanding of drivers to create the ultimate driving experience for the 21st Century.



## Chapter 1.0

### The pleasure principle

"Sometimes, when I'm driving across the moors at dusk on a summer's night, there are moments when I'm going downhill and it feels like falling into the landscape. I feel as if I'm swooping down like a bird of prey, the moors coming up to meet me, and somehow it's as if you are giving up control but yet still in full control. That's trusting the car, I suppose. I'm responding to it and it's responding to me, but it's all instinctive. I only get that feeling in a car – in a plane you're above the landscape, on a train you're looking sideways on like a spectator. In a car you see head on, and you feel as if you're inside it, you-and-the-car-as-one sort of thing."

**Female driver, 36, Penzance**

"To be honest, I love my drives to work and back. It's the one time in the day you're not getting pressure from home or work. I've got my coffee in the cupholder, I've got my iPod with stuff I've downloaded from Radio 4, and I feel cocooned – I think the interior of the car itself helps with that because it's built all around me. It all comes down to the steering wheel with me. I like a big thick one. I suppose it's a macho thing, but I find holding a big thick steering wheel like the one in the 5 Series in my hands makes me feel as if I have extra control and security... I don't even mind a bit of built-up traffic. Not endless, obviously, and especially not filtering in and out of lanes, will you let me in, all that... but ten minutes or so of slow-moving traffic... I think good, I'll get to the end of this programme. Ten more me-minutes! You don't have anything to prove other than getting from A to B."

**Male driver, 35, South London**

#### 1.1

##### The way you make me feel

The quotations above, taken from two respondents out of the dozens of interviews conducted for this report, capture many of the complex and unique emotions associated with contemporary driving. There is, for example, the delight in both exhilaration and security; the feelings of emotional and physical pleasure; the enjoyment of a car's particular kind of personal space, and the trickiness of dealing with fellow road users. Such feelings of pleasure are of course much in evidence in the world around us, and yet it is striking that, for all the debate about car use over the past few years, very little has been written or understood about them.

Specialist motoring magazines and TV programmes rarely explore the human experience of driving beyond speed and controllability, despite the fact that the way we feel clearly determines the way we drive. "Don't ask me why, but the way I feel when I get in the car in the morning sets how I'll feel for the rest of the day. It's like the car's telling you how to be," the male driver above told us.

According to Martin Ertl, Innovations Manager at BMW's Projekthaus in Munich, identifying a key "meeting moment" is now taken into account in the design process. "A car is a story you can break down into chapters. On a typical day, you leave your house in the morning and you walk to your car – the first thing you see is its overall appearance, the sculpture, the proportions. You have an overall impression of 'wow'. Then you open the car and sit in it.

---

01  
Love at first sight: from the moment they are seen, cars stimulate complex and unique emotions in drivers

---

01

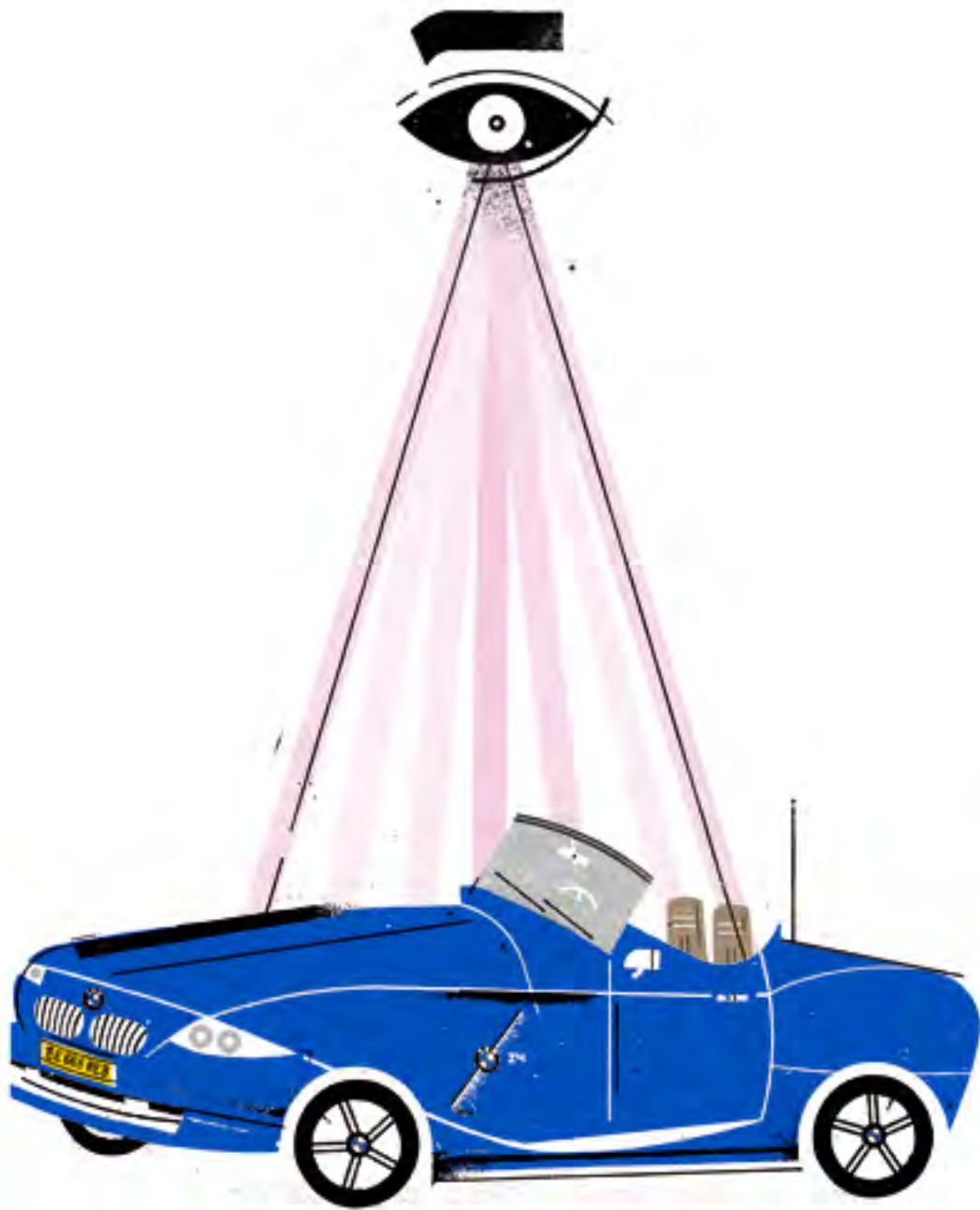

Our aim is that everything must work ergonomically: the materials, your visibility, and the surrounding environment. You start the engine and the driving experience comes in. Everything about the car stimulates your senses – that’s what the overall driving experience is all about.”

In other words, the way the car looks and feels partly determines how you drive – a clear example of the ‘emotional design’ principle followed by BMW. “If you like the look of a product, you become a better user of that product,” says Don Norman, one of the world’s foremost authorities on the emotional design movement. “You learn to love it and become a better user of it. A virtuous circle is established.” In this context, it is interesting that the ‘meeting moment’ was best articulated by the interviewee who also revered steering wheels – BMW designers imagine steering wheels as a car’s ‘handshake’.

## 1.2 Just the two of us

Of course our driving will be affected also by new emotions and new experiences on the road as the day wears on. Our feelings towards the car may change too – indeed, these feelings are more likely to be in flux than those we have for most other objects, because we often identify with cars ‘somatomorphically’<sup>1</sup>. Somatomorphism is a psychological term for a human tendency to identify with certain objects as if they were alive, animate and conscious – another being, or an extension of ourselves. Sailors traditionally identify with their ships in this way, as some people do with

their homes. This partly explains the deep sense of pleasure associated with driving. The car is felt to have a body and a character, and satisfaction lies in the experience of skilfully controlled interaction as we move through road contours, gears and space. It is somatomorphism, and the slight difference in the way in which men and women experience it, that explains an interesting behavioural quirk associated with cars. Our researchers generally found that men are less comfortable discussing their feelings about people, experiences and objects, but when it comes to feelings about cars, they are equally as comfortable as women – perhaps more so. It is difficult to think of other subjects that would elicit responses from 35-year-old males such as this one:

“I like to listen to my car. You can hear when the turbo clicks in – that ‘vacuum-cleaner’ effect. You can just feel the giddy-up effect, and the sensation of power is brilliant – you can feel it through the steering wheel and the back of the seat.”

Male driver, 35, London

This would seem to be rather neatly summarised by one female respondent who made the very direct link between the car and her husband’s psyche:

“Cars are a happy thing for us. My husband is the biggest car fiend. For him cars are a complete passion, for me it’s an aesthetic girl thing. If you removed my husband’s scalp, you would see pistons and oil instead of a brain!”

Female driver, 33, London

01  
The car as a story: from sight to touch to experience, cars act on us in a variety of ways

01

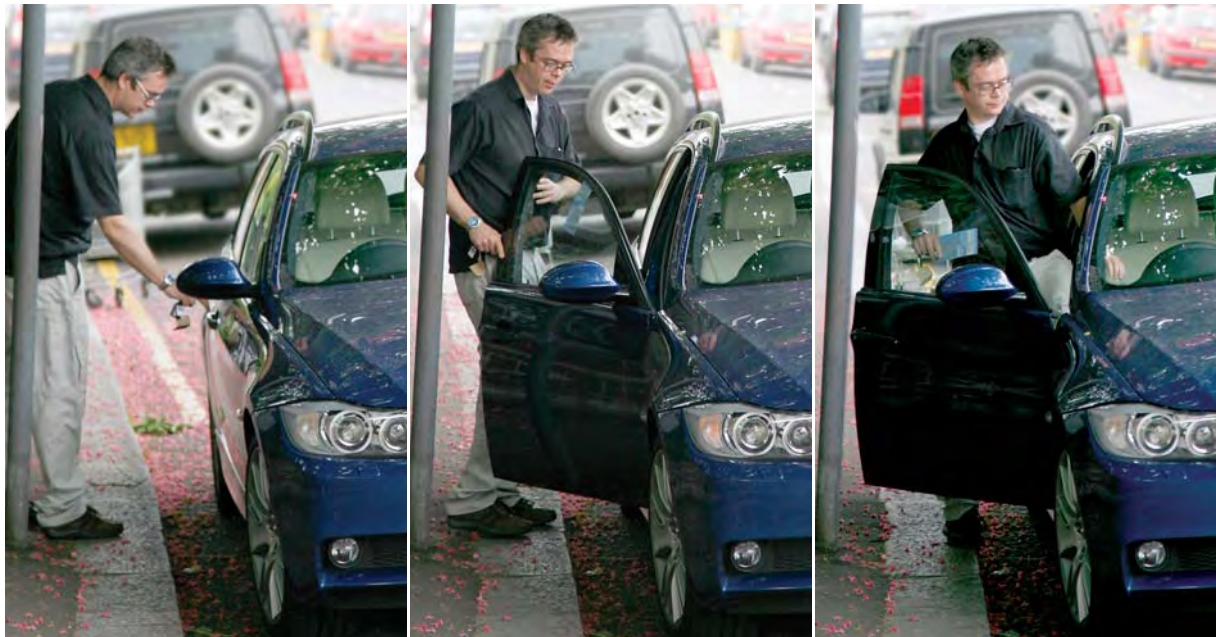

Why should this be? Well, because men are less conscious of their own bodies than women, their sense of self is tied less to their physical being, and more easily projected on to their somatomorphic objects such as cars. This may offer an explanation as to why some men describe their car as being an 'extension' of them, why many men resent other people touching their cars, and why men often attack other men's cars in the course of disputes. In contrast, because women have a more direct identification between body and self, they project less, and are thus more likely to think of their car as being a separate entity. This may in turn explain why women are more likely than men to name their cars; earlier this year a survey<sup>2</sup> showed that 26 per cent of women, as opposed to 16 per cent of men, had nicknames for their car. Among unmarried women the figure rose to 30 per cent.

"My car is called Keith – it had to be a boy because it is black. I will always refer to it as Keith, like 'don't you think Keith looks clean today?' My old one was green and was called Mandy – mainly after the song. My ex-boyfriend used to have a white Rover which he called Roy – after my dad I suspect."

Female driver, 24, Bournemouth

### 1.3

#### Embrace the future

There is little evidence that people's enjoyment of driving and affection for their cars is decreasing – in fact the opposite is true – but it is clear that our culture's

relationship with the car is becoming more complex. Most importantly, social, economic and environmental issues such as climate change, road congestion, pollution, and rising oil prices mean that we cannot continue to keep increasing the number of petrol-based cars on the road, and the annual mileage they do. Perhaps in response to some of these concerns, drivers have begun to shift their priorities when making purchases. As high levels of reliability and performance have become standard across almost all car ranges, we have taken them for granted and begun to look to our cars to stimulate feelings. And the desire for luxury for its own sake is being edged out by an interest in cars that meet our own personal demands in an engaging way. One response on the subject demonstrates the complexities of these demands:

"I've got two kids and have always resisted people carriers – I didn't want a mumsy car. I would never have put myself down as a 4x4 person but it looks like a really beautiful stylish saloon and gives me extra seating. I'm also a bit of a speed merchant – this car fits exactly all those things. I did a lot of research, and this fitted the bill for me exactly. It looks stunning, it's silent, has black windows and beautiful lines. It's an impressive beast. It purrs."

Female driver, 38, North London

Chris Bangle, BMW Group Design Director, believes BMW has had to rethink its approach in order to meet these social changes in which, broadly speaking, the aspiring social climbers are being replaced by the social progressives<sup>3</sup> who are more interested in the 'feel' and

---

02  
Making friends: the steering wheel is the handshake of the car

---

02





01



'experience' something has to offer. "What makes the car alive is for it to be responsive, animate," he says. "Does it react, have its own opinion, does it communicate, does it move you? There has to be more of a message than 'I'm beautiful, I'm powerful, I'm sexy'. There has to be an intellectual side to it, a responsibility side. People buy cars that they are passionate about, they don't buy cars that they just use. If the car isn't you, take a taxi."

### 1.4 The same but different

Of course this reinvention of the car for a new century has had to allow for the fact that different people have different approaches to driving. This is widely recognised, and indeed driving styles are often found to offer intriguing insights into different types of behaviour. Take, for example, Bettel and Finke's<sup>4</sup> distinction in *Chaotic and Ordered Thinking*:

"Consider differences in driving habits that ordered and chaotic thinkers are likely to exhibit. Ordered thinkers usually plan their routes in advance, carefully record their mileage and try to anticipate any mechanical problems that might arise. Most chaotic thinkers would seldom plan their routes, care little about their mileage, and add oil whenever the warning light comes on. They would rarely display the ordered thinker's preparedness or punctuality, yet they would usually be better at dealing with unexpected breakdowns or emergencies."

The Cambridge Strategy Centre<sup>5</sup>, a business-to-business company, who work with clients such as Phillips, Coca Cola and ASDA, analyses consumers according to Jungian personality archetypes, goes further, and suggests that approaches to driving crystallise differences between two fundamental personality types: 'instrumentalists' and 'expressives'. Instrumentalists regard the car chiefly as a convenience that allows them to move between places, and ask "what can the car do for me?" Expressives see it chiefly as an expression of their personality, and a chance to explore their own competence with a tool. Both types have emotional connections with their car, though these connections are different; in essence, the instrumentalist sees the car as a sentient, emotional entity they must try to control, whereas the expressive sees it as a rational piece of machinery they must adapt to meet their needs. It is in understanding these kinds of feelings that the challenge for car designers of the future lies.

### 1.5 Where dreams are made

In order to meet the challenge of designing cars for this new era, BMW built the Projekthaus in Munich, a spectacular building purposely designed by German architect Professor Gunter Henn<sup>6</sup> to house the BMW innovation process of design. Henn was specifically charged with creating a building that would allow everyone working on a new car project – there can be as many as 12

---

01 The human element: facial features, personality, smiles and joy in every aspect of the BMW

---

02 Which are you? Drivers fall into two camps

---

02

Instrumentalists	Expressives
In their most extreme form, instrumentalists will tend to only interact emotionally with their cars to the extent to which they can be seen as having sentient personalities. This is the group most likely to have names for their cars.	Expressives see cars as simply a rational tool for them to explore their own competence. Pride in their car equates to pride in themselves – but they'd never acknowledge this implicit emotional bond.
Satisfaction will simply be their ability to achieve the tasks set for them in a predictable manner using the technology and features made available to them. Known failings or idiosyncrasies can be reasonably tolerated.	Similarly, journeys are a test of man and machine, with the machine responding perfectly to the master's touch. Blurring the distinction between man and machine is key to this group – they drive at high speed when the opportunity presents itself.
The feeling that 'the car has a mind of its own' or acts on its own accord confirms what they fundamentally believe – that cars respond in an emotional, rather than rational, way.	Equally, they prize being able to corner with precision but their mastery is also expressed by reining back all the potential except when the moment demands it.
Beyond a certain basic level this becomes frustrating and frightening. Vague strangeness like "we have to close all the windows before the windscreen wipers work" can create affection, whereas pressing a button and you can never find Radio 4 again suggests technology getting out of control.	The ideal car is a stripped-down machine with just the necessary controls on board – if this group wants to make changes, it will do it properly in 'the pits' with great care, research, precision and attention. However, the ability to customise at source about fundamentals is key to this group.
Instrumentalists will be faithful to the multiple personality 'three cars-in-ones' idea, but in practice they will find a single version of the car that suits them – taxi, load shifter or fast truck.	They hold firm to the idea of 'one car, one job'. The 'three-cars-in-one' idea feels like a compromise. If they want to drive fast, they choose a fast car. If they want to off-road, they choose an SUV.
They will swerve to miss an already flattened hedgehog – hasn't the poor thing suffered enough? – and yet be oblivious to the 15-car pile up that their caring manoeuvre caused.	Cars must deliver one main purpose before it starts trying to be other things. If a car has lots of controls, they must do something significant or are otherwise a distraction.

underway at any one time, each with up to 200 people working on it – to be updated simultaneously in real time. His solution was to build, inside a huge central atrium, a glass tower housing all the car project models being worked on. Anyone wishing to know what was happening with a certain project merely had to look at the tower.

Noting that research at the Massachusetts Institute of Technology<sup>7</sup> (MIT) has shown face-to-face meetings to be vastly more efficient than email and telephone, Henn also designed the space to encourage easy movement between departments. Another masterstroke was to ensure designers had access to high-ceilinged space. “Somehow, creativity comes via that third dimension, where you can look up,” Henn says. “It’s interesting that artists and creative people so often work in studios with high ceilings.”

“The deeper benefit of this is to connect the emotional to the rational. People say working is now a new kind of experience – they feel it now. They feel how the project process works, how the project is developing and they are connected to 200 people working with them on this project.”

In some ways the Projekthaus belongs to the architectural movement that has moved towards a process whereby the architect begins with human behaviour, and allows that to determine the form of the building. Projekthaus is unique because, as Henn says, “BMW is the only company in the world to create the spatial embodiment of innovation.” Last year

*BusinessWeek*<sup>8</sup> cited it as one reason why BMW featured in its poll of the world’s most innovative companies.

The celebrated Swiss firm Herzog & de Meuron<sup>9</sup> has applied similar principles to its work placing people at the heart of their design and in the US the design company IDEO<sup>10</sup> has rewritten the rules of planning and design. Their system starts with explorations of both mood and place, and then turns the findings into briefs for developers. When they worked with Rem Koolhaas on the launch of Prada’s groundbreaking store in New York, their Human Factors specialists interviewed and observed the staff developing invisible technology that allowed Prada staff members to choreograph the sales experience. In-store devices, such as interactive dressing rooms, allowed staff to focus completely on customers with interactive dressing rooms.

## 1.6 Composing cars

In a similar vein to the innovative design of Projekthaus, BMW Group Design Director Chris Bangle, who joined the company in 1992, is responsible for redesigning the BMW range to meet the challenges of, and to set the agenda for, the 21st Century. His hallmarks are dramatic, stylised lines, curved surfaces and a sculptural bodyshape, and his range of influences somewhat broader than that associated with automotive designers: he cites Stravinsky’s *Rite of Spring*, the work of Italian futurist painter and sculptor Umberto Boccioni, and the couture designs of Coco Chanel as key influences. “Our designs

01

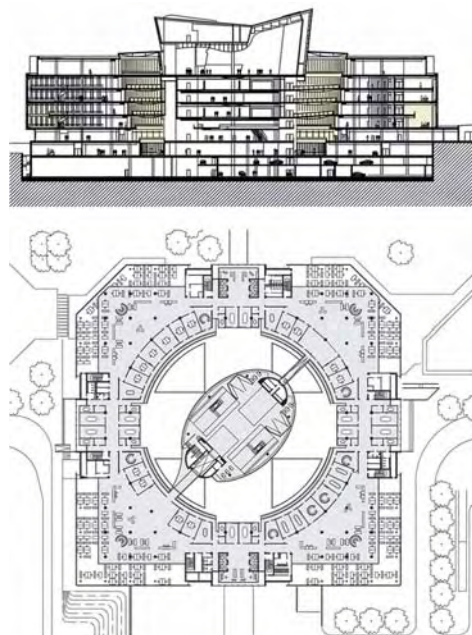

---

01  
Theatre of dreams: Projekthaus  
is unique and embodies BMW's  
innovation at every level

---

02  
Master at work: Chris Bangle,  
BMW Group Design Director

---

03  
Curved surfaces on the road:  
the Z4 embodies a vision for  
the contemporary, dynamic car

---

02



03





01

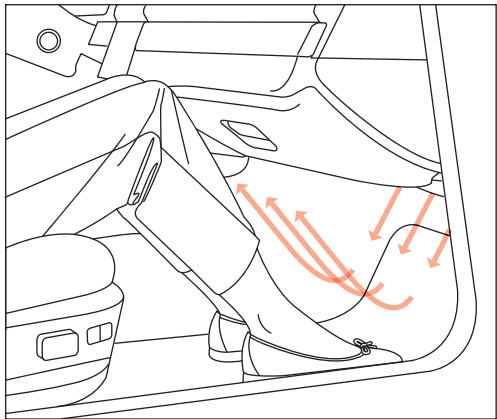

Climate

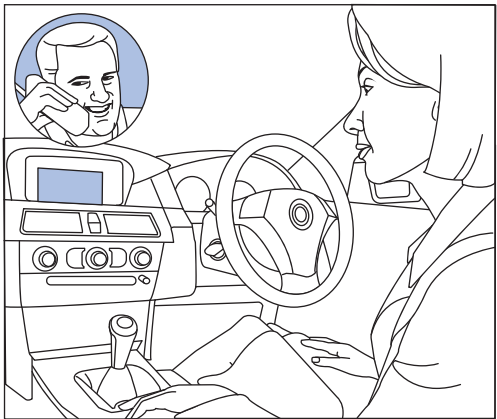

Communication

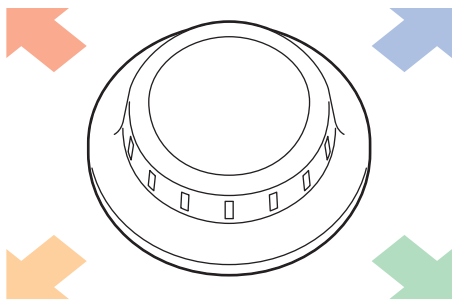

Entertainment

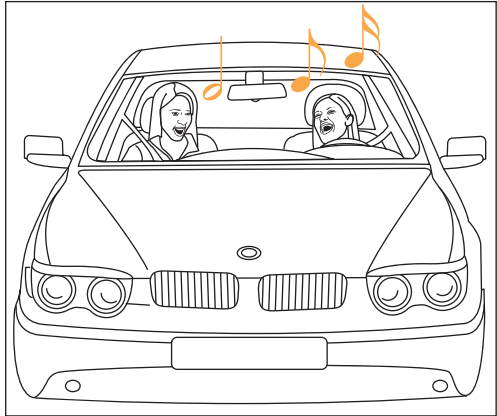

Navigation

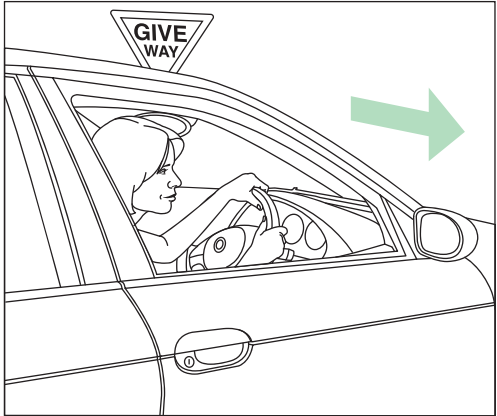

are about engaging you; it is a two-way flow, it lives through you. When you think, 'a car' today, let's take that apart; how big it is, how I park it, how I store it, how I sell it, how often I drive it, how my life is enhanced by it. All of that is 'a car'".

Designs for BMW build in a visual complexity which, like any great art, reveals its character slowly. "With the Z4, for example," he says, "the concave and convex surfaces, and light and shadow that plays across them, relate to the eye in unexpected manners. You want the car to tell you certain things, but as soon as it does you want more or different things. That's what happened with the exterior of our cars, we had the courage to set elements in question against one another.

"Story writers know that the secret of a memorable character is someone where the more you look at them, the more questions are raised. People form a relationship with our cars, they discover them slowly. We want to achieve the growth of a long-lasting, deeper bond."

BMW's are designed to deepen this 'story' and forge a strong emotional experience.

Bangle recognises that the clearest and most immediate area of change in the relationship between driver and car is in how new technology is revolutionising what driving is. Existing BMW innovations such as iDrive, Active Steering, Active Cruise Control and Dynamic Drive have enabled more intuitive communication between driver and car, and developing technologies allowing the car to recognise questions, gestures and even emotion will in the future enable cars to react more like humans, further reducing the need for drivers to adapt to machines.

Crucially, it is the conjunction of car and body through technology that provides the distinctive next step in the experience of driving. As the car develops, the complex ergonomic characteristics of cutting-edge technologies – for driving and for the optimisation of driver experience – the engagement between car and driver becomes both more subtle and more deep-seated.

There are parallel developments in various fields of industrial design and particularly in architecture, where practitioners such as Zaha Hadid<sup>11</sup>, who designed the BMW Central Building in Leipzig, and Eddie Sotto<sup>12</sup>, a former Disney Imagineer, are revolutionising buildings by embracing user-responsive technology. Much of BMW's work for the future will be concerned with the connexity between driver and machine; the cars of tomorrow will still be driven as machines for mobility, but as the cars of today show, they will increasingly be experienced as objects of emotion. "Yes, we want to go beyond immediate visceral response and get something deeper," Bangle adds. "It's a discovery process."

---

01  
I think therefore iDrive: BMW's technology converges a range of driver features into one simple control unit

---

## Chapter 2.0

### The homing instinct

"I hate letting someone else drive my car, because when I get back in, everything's wrong. The seats are set wrong, and the radio, the mileometer, mirrors, stuff in the racks on the doors will have been shifted... It's very personal to you, isn't it? Something else I dislike is when you give a lift to someone you don't know very well, and they open your glove compartment without asking. I suppose it sounds petty – I don't even keep anything secret in there – but to me it's like a stranger coming to our house and wandering off to have a look in the bedrooms upstairs. Mind your own business! But I suppose it's because I feel at ease in my car. It's like a bit of my own space that I take with me from home, and I can put what I like in it, do what I like in it, within reason! It's like a little pod."  
Female driver, 44, Liverpool

"I cannot stand a cluttered car interior – can't stand it. I almost think there is something wrong with people if they have a cluttered interior."  
Male driver, 36, South London

#### 2.1

##### Home from home

When people talk at length about their cars, a comparison they often make is between their car and their home. They might point out that their car "lives" in their home, in its own room – the garage. Or that it often functions as a mobile, personal room itself – useful when you change clothes, say, or eat a picnic on a rainy day, or even hold an impromptu meeting with a work colleague. Many drivers compare their cars to specific areas of a home, with some seeing it as a sensory zone:

"My car is most like my bedroom – I feel comfortable and at ease in it."  
Male driver, 21, Hull

Others see it as a spruced and tidy social space:

"It's like my living-room – a place where people can get together and have a nice time. My car has a DVD player, and I keep it clean – I'd hate to get into a car that has rubbish all over the floor and I'd be embarrassed if my car was like that."  
Male driver, 40, York

Another likens the car to the office because it enabled her to enjoy a certain pleasure in being organised (several men and women we spoke to specifically mentioned efficient car packing as a source of joy and pride).

"My car's very functional – I put stuff into the boot and pack it in a certain way and it all fits in, but it's also pleasurable knowing where everything is – that you've packed it and the packing works. If you go out and take a bag for the baby, you know where everything you need will be – 'nappies, front pocket, right' for example."  
Female driver, 40, South London

Personalisation, a variety of emotions, a sense of enjoyment gained from the interior of the car; these are recurrent themes in discussions of how cars have become crucial to our management of 'life-space'. In a world that demands fast-paced mobility – as well as requiring reflection and space to think – our cars have

---

01  
Moving house: the car allows us to extend our domestic and work life into the public sphere

01



01

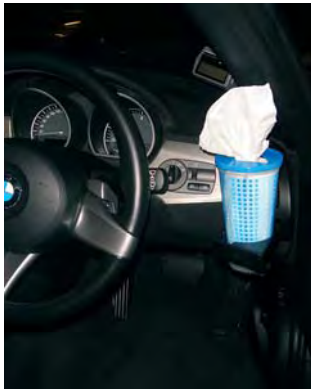

become versatile 'places' between home and work, between managing family relationships and negotiating public and private engagement.

## 2.2 The cupholder principle

One secret – perhaps even guilty – pleasure of which almost all our interviewees spoke fondly was eating in the car. The chef Heston Blumenthal<sup>1</sup> vividly recalls picnics with his family when on holiday as a child; a property developer from the North East spoke of 'mobile picnics' with his partner as one of his favourite eating occasions – it was one of the few times, he said, when they could be together without being interrupted. Snack manufacturers are well aware of this growing trend of course, and now create foods bearing in mind the 'trouser factor'<sup>2</sup> – referring to the chances of pieces of the snack falling into people's laps when they eat in cars. This is one reason for the increasing use of mayonnaise in sandwiches and caramel in chocolate bars to bind the ingredients.

Car manufacturers can enhance the joy of these mobile picnics or transit snacking with thoughtful storage design, and indeed one feature arouses astonishing levels of passion in car users. For all the sophisticated electronics now at their disposal, for all the issues affecting drivers in contemporary society, few things prompt more eager debate than the humble cupholder. The following sentiments are typical:

"Outside of the satnav, the cupholder is the most important thing in the car. That and the iPod holder – because I spend so much time in the car, I'd go as far as to say it was one reason for choosing the car. The BMW cupholder is the best on the market for sturdiness – they also have one on the passenger side, whereas mine is on the central console."

Male driver, 40, York

"I hate my cupholder – it's not wide enough. It has been such a disappointment. You buy a coffee, and the cup will be wider than my cupholder, so the cup perches on it and spills coffee down the audio console on to the volume control. Parts of the volume control knob cycles are very stiff or very loose. It's probably not the greatest piece of ergonomic design."

Male driver, 35, South London (non-BMW driver)

That people will talk with such passion about a simple device for holding their drink is indicative not only of the importance of the domestic element of the car, but also of the value of emotional design – cupholders came about through designers thinking simply of users' desires as well as basic needs. Because of this, the cupholder could perhaps be seen as an icon of the new shift in car design. Henry Petroski<sup>3</sup>, Professor of Engineering and History at Duke University, North Carolina, suggested as much in an article in which he claimed to have "repeatedly heard articulate people say that their family's latest automobile purchase hinged on which cupholders worked best for them". Writing about the socio-cultural significance of the cupholder (we did say people took this seriously), the French cultural anthropologist G Clotaire Rapaille<sup>4</sup> suggested the psychological cues went even deeper:

---

<sup>01</sup> Small is beautiful: the humble cupholder is fascinating motorists, designers and philosophers

---



"...what was the key element of safety when you were a child? It was that your mother fed you, and there was warm liquid. That's why cupholders are absolutely crucial for safety. If there is a car that has no cupholder, it is not safe. If I can put my coffee there, if I can have my food, if everything is round, if it's soft, and if I'm high, then I feel safe. It's amazing that intelligent, educated women will look at a car and the first thing they will look at is how many cupholders it has."

While these notions may be valid, our research led to a different conclusion. When people were asked to expand on their feelings, they often seemed to see the cupholder as a kind of small detail that summed up either the positive or negative wider aspects of the car. Our mobile-picnicking property developer recalled his wife buying a new BMW 320d:

"I remember her getting it. It had full-spec top-of-the-range everything, full leather interior, turbo, telephone all plumbed in, the lot, but what she was really excited about was the cupholder, because her old car hadn't had one, and this one comes out just right. It makes a lovely noise. We went out and got a coffee and an almond croissant just to try it."

It is perhaps more in tune with most people's feelings to say that a cupholder is not only useful, but also one of those small details that encapsulates a general quality, like a small act of extra courtesy that makes us fall in love with a hotel, or a small idiosyncrasy in a loved one. One could even talk of the 'cupholder principle' in connection with small, emotional experiences that

- 
- 01  
Feel the sun: speedy sun roofs and fast soft-tops make us go weak at the knees

---

  - 02  
Cupholder heaven: have your drink safely stored and close by

---

  - 03  
Electronic Seatbelt Handover: makes plugging in tussle-tangle free

---

  - 04  
Special treatment: Individual Climate Control keeps passengers cool

---

  - 05  
Scale new heights: the Automatic Tailgate opens to the height of the driver's choosing

---

  - 06  
Light me up: Follow Me Home headlights will brighten your path
- 

1



02

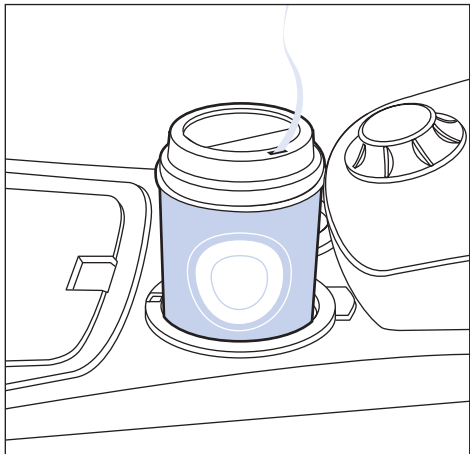

03

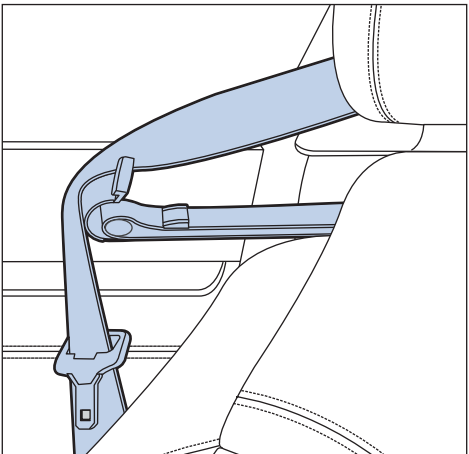

04

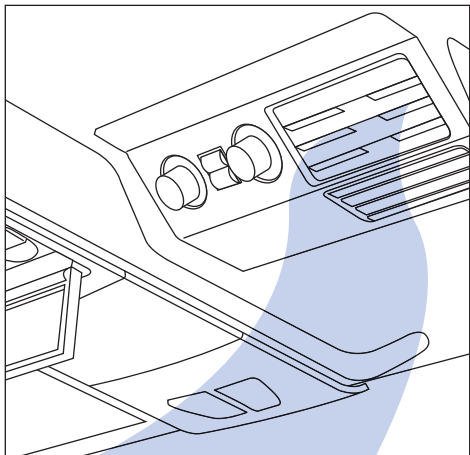

05

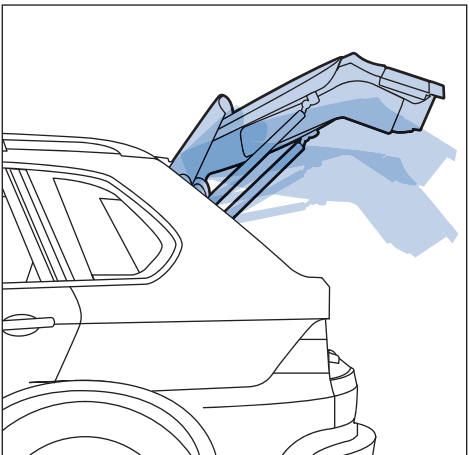

06

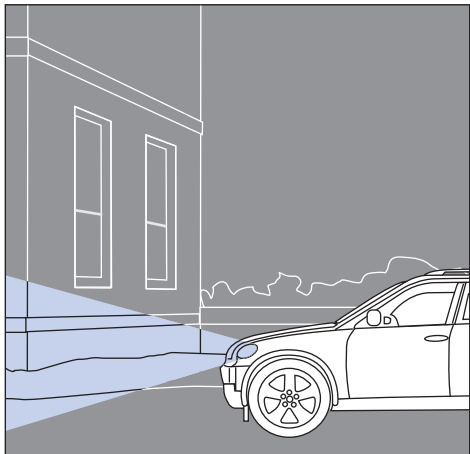



prompt disproportionately warm, positive feelings in the user and this is precisely the sort of process the BMW designers have been working with. Leslie Harrington, President of LH Color<sup>®</sup>, has 20 years experience of using emotion to captivate the reader: "There is a huge drive to understand consumer behaviour around products, and product choices. We used to think that product choice was a rational thing; this cupholder has a diameter of 60 millimetres and it works well so I will buy it.

"But what researchers have found is that affect plays a big part in cognition and choice. You can't just put emotion in this separate box when you're talking about people making decisions. Cognition, affect, and behaviour are all inextricably linked."

### 2.3 Me-time: cocooning and the joy of the commute

Cars are not only about travelling, then; they also offer various and complex joys in themselves. As the driver noted on page 4, these joys can give rise to a feeling of being cocooned by the car, and driving can represent an everyday escape in the sense that the car absolves the driver of any other responsibility to be anything more than a driver for the duration of the drive:

"My favourite drive is to and from the gym, often before we go out on a Friday night. You know the rest of the

time is going to be social, so it's nice to have a bit of me-time when you can listen to the radio and think about the day."  
**Female driver, 27, South London**

Surveys have shown conclusively that among western consumers, reverence for cocooning is increasing. For some time researchers have noted that the 'compressed' demands of modern living create a desire for periods of 'me-time' and the spectacular growth of a leisure sector (spas, health and beauty centres, retreats, pampering treatments) based on stress-relieving self-indulgence appears to confirm how seriously people now take this idea. It would seem fair to assume that the mobile-phone network that advertised with the slogan "Good things can happen when your phone's off"<sup>6</sup> has taken notice of this.

Nevertheless, it is still surprising to learn that many people – well over half of those we interviewed – valued the car's refuge so much that they spoke of positively enjoying the commute to work – an experience commonly perceived as unpleasant. Many drivers began by complaining about the toil of commuting but, as was the case with this teacher from East Yorkshire, went on to confess a secret relish for the isolation:

"Commuting to work on the M1 is a real pleasure. I have time to reflect on my day ahead, go through my classes, sing at the top of my voice, test out loud what I might say to unruly pupils after a difficult previous day, and, dare I say it, pick my nose. There is no husband to tell you that you shouldn't be in the middle lane, or that I

01 Work the line: making the most of the daily commute

01



01 Leave work and jump in the car to begin the daily drive home



02 Once settled, start my journey by making a call to my boss to wrap up the working day

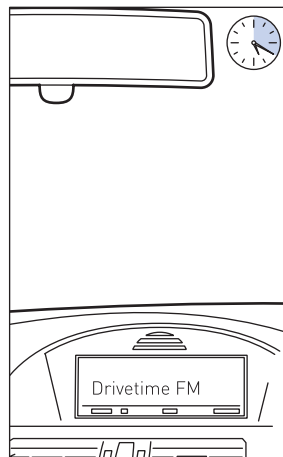

03 Use steering wheel buttons to switch from calls to the news and listen to the latest bulletins



04 Start to unwind by switching to favourite music on the MP3 player

need to put my foot down, yada yada yada. I can get on with what the road throws at me and feel satisfied that I did a good job when I get there. I cry easily especially when certain songs come on the radio, and I find that crying is good when you are driving alone – although it can make visibility difficult! It's strange, but I particularly enjoyed driving when I was pregnant with my first daughter. The first time she would move on any given day was in the car on the way home. I used to imagine what she would look like, how she would grow up and what kind of person she would ultimately become... I felt like it was us against the world."

Female driver, 34, Hull

Sometimes this isolation is enjoyed for its own sake:

"I drop my children at 6.45am, and then go straight to work for 7am. When I'm in the car on my own, though, I love that. With two young children I suppose that maybe I don't get a lot of 'me-time', and if I find myself driving on my own then that is 15 minutes' peace and quiet, which is rare."

Female driver, 20, North London

Other drivers, meanwhile, exploit congestion to push against their responsibilities to work. Several said they sometimes actually welcomed hold-ups because it meant a respite from work, and because traffic-flow problems are so commonplace now, arriving up to 30 minutes late is less stigmatised than it used to be.

"Everyone loves to bitch about traffic – 'oh, the M25 was awful today' – but it's not within your control so you can

surrender to it. Small delays are fine, even welcome. Forty minutes is the optimum for me – I can enjoy the extra time in the car, plus not have to panic about having to work too hard to catch up."

Male driver, 35, South London

Seventy-two per cent in the UK (outside of London) drive to work, and we have the longest commute time in Europe – an average of 45 minutes. In 2003, when the RAC<sup>7</sup> asked commuters why they chose to drive to work, 23 per cent of respondents answered: "Because I enjoy driving." It seems likely that this figure has increased – a likelihood that surely has implications for transport planning. If our roads are clogged with people who are happy to be there, then reducing congestion is likely to be a tougher job than once expected.

The enjoyment of the commute is corroborated by BMW Driver Interfaces Psychologist, Klaus Bengler: "We think of the commute as a painful part of the day, but we're seeing a surprisingly high proportion of people who are telling us they really enjoy that part of their day. We're seeing that some people positively choose to drive to work, because they are looking forward to the time and space it provides. That's part of their reason for choosing a BMW. There's even a fetishisation of it – drivers want their morning commute to be an absolutely perfect experience."

Communication technology is now radically altering the psychological nature of the car, changing it from a

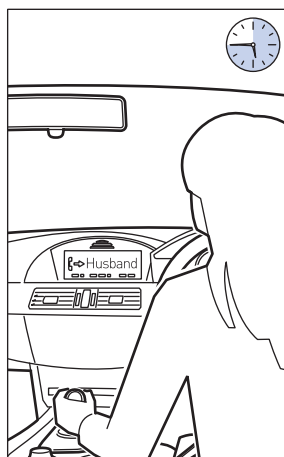

05 Call from home received to arrange collecting the children from a friend's house

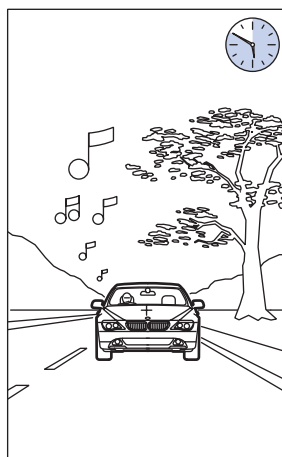

06 Return to music for the final stretch and begin to feel relaxed

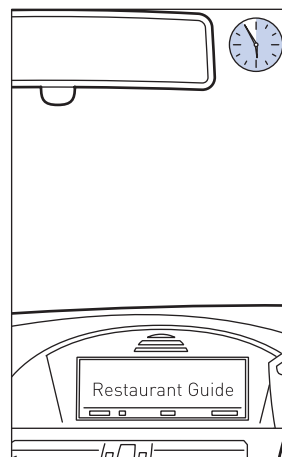

07 Call BMW Assist to find restaurant for dinner on Saturday night



08 Arrive home feeling refreshed, organised and ready for family life

solitary space to a highly connected, reassuring and even entertaining one. Mobile phones, as well as navigation and entertainment devices, provide forms of social 'presence' and for Klaus Bengler this, coupled with growing commute times, poses a host of new questions.

"Once people are sitting in the car for longer we ask, 'What can we do for them?'" he says. "We're seeing that the car is viewed as a space from which drivers want to communicate with others. For example, the chances are high that you'll need to make a business call, or maybe you'll keep in touch with friends, without increasing their drive workload. Features we're developing, such as gesture-activated phones, are going to provide the means to do this."

## 2.4 The feel-good factor

Many of people's feelings about cars are, like those expressed in this chapter, concerned with the machine seen from the inside, and yet for years interiors have been relatively neglected by manufacturers who chose to focus on the external styling. Chris Bangle's emotional design philosophy counters this, however, placing a strong emphasis on design "from the inside out"; he cites as a key influence the architects Herzog & de Meuron<sup>8</sup>, famed for not only allowing the necessary internal forms of their buildings to dictate the external ones, but also allowing the interiors to be

visible from the outside, demonstrated in their evocative Laban Centre in London.

This is quite in tune with the times, since research shows potential car purchasers set increasing value on interior specification and ergonomic benefits. This is not to say that drivers are no longer concerned with prestige and looks, simply that their values are now more complex and multidimensional – and their own research is deeper. In many cases internet trawling means that customers now know as much as salespeople at the showroom. As one BMW dealer in Oxford said "Customers will always have previously checked out price, fuel consumption, insurance, what options they have as standard and what they can get."

Our interviewees certainly spoke enthusiastically, even lyrically, about their car interiors:

"My seat is completely relaxing and comfortable – it's like getting into a club-class chair with the heated seats. Inside, it's really spacious. There's no gear stick, and the seats are just really wide and comfortable."  
Female driver, 38, North London

"Having the controls on the steering wheel was just a real thrill and the aircon was good to have – you could even choose for it to cool the glove compartment. I loved that. You feel the desire to talk to other people about the things that make the experience nice."  
Male driver, 35, Birmingham

---

01  
Designing from the inside out: architects's Herzog & de Meuron's Laban Centre in South East London

---

02  
The magic touch: the multi-function steering wheel brings music closer

---

03  
Focus on the future: Michael Ninic, Head of Interior Design BMW Cars (left) at work on the CS concept car

---

01



02



"All the coloured lights on the dashboard – there's something about the colours and the design that makes me feel safe at night. They're beautiful, but also they look technical and scientific, so you feel you're in a good machine, but also one that was made by people who understand people."

Female driver, 27, Edinburgh

The proportions inside the cabin will depend on the kind of car being designed. In the X5 and X3, for example, there will be a 'command position', with low dashboard and high seat so you have a good overview and feel on top of everything – a design which, Ernst Assman of BMW Interior Concepts, says, essentially harks back to the SUV's ancestry in agricultural vehicles whose drivers needed to see the layout of the rows of crops beneath them as they drove. In a car designed solely for the road the driver sits low, "right in the centre of gravity in the car because then you feel the movement as if the car was a part of you", with a high dashboard. Your concentration is directed towards the road. It's like, to take an extreme example, in a Formula One car – there the driver is so deep down he cannot even see over the car's nose. It doesn't matter because what he wants to see are the wheels and the corner. The saloon sits in between these of course."

With the physical sensation thus taken care of, it falls to people like Head of Interior Design BMW Cars, Michael Ninic to create the right mental state in the driver by setting the right mood and tone. Ninic and his department

approach this with the seriousness and reverence of a fashion designer or artist – indeed, BMW sends its interior designers to London to take inspiration from Fashion Week, and also asks design students on placements to design the interior of white 1.5 cubic metre boxes to induce different emotional experiences. Ninic believes there are two elements that create the perfect sensory space:

#### i A sense of control

"Our customers should feel passion when they drive their cars. First of all that means feeling control, and so it's our challenge to ensure that the interior helps to create a sense of control. Our main focus is the driver position, and how the driver will feel in the car. The steering wheel, pedals and instrumentation are focused around the driver being able to control every aspect of it. For example, the dashboard is organised along clean horizontal lines, because horizontal lines also help to create a sense of control and stability."

#### ii Materials relevant to the times

"People are increasingly seeing the car as a part of their broader lives, and they want it to reflect the fashion sense that they have – 'this is my car, and I have this car because it fits my lifestyle'. We can use warm, soft colours to create a feeling of wellbeing, as we did recently with the new 5 Series interior. In that, we used bamboo – a very contemporary wood that helps create a certain atmosphere. Today it has a Zen feeling around it for Europeans."

03





01

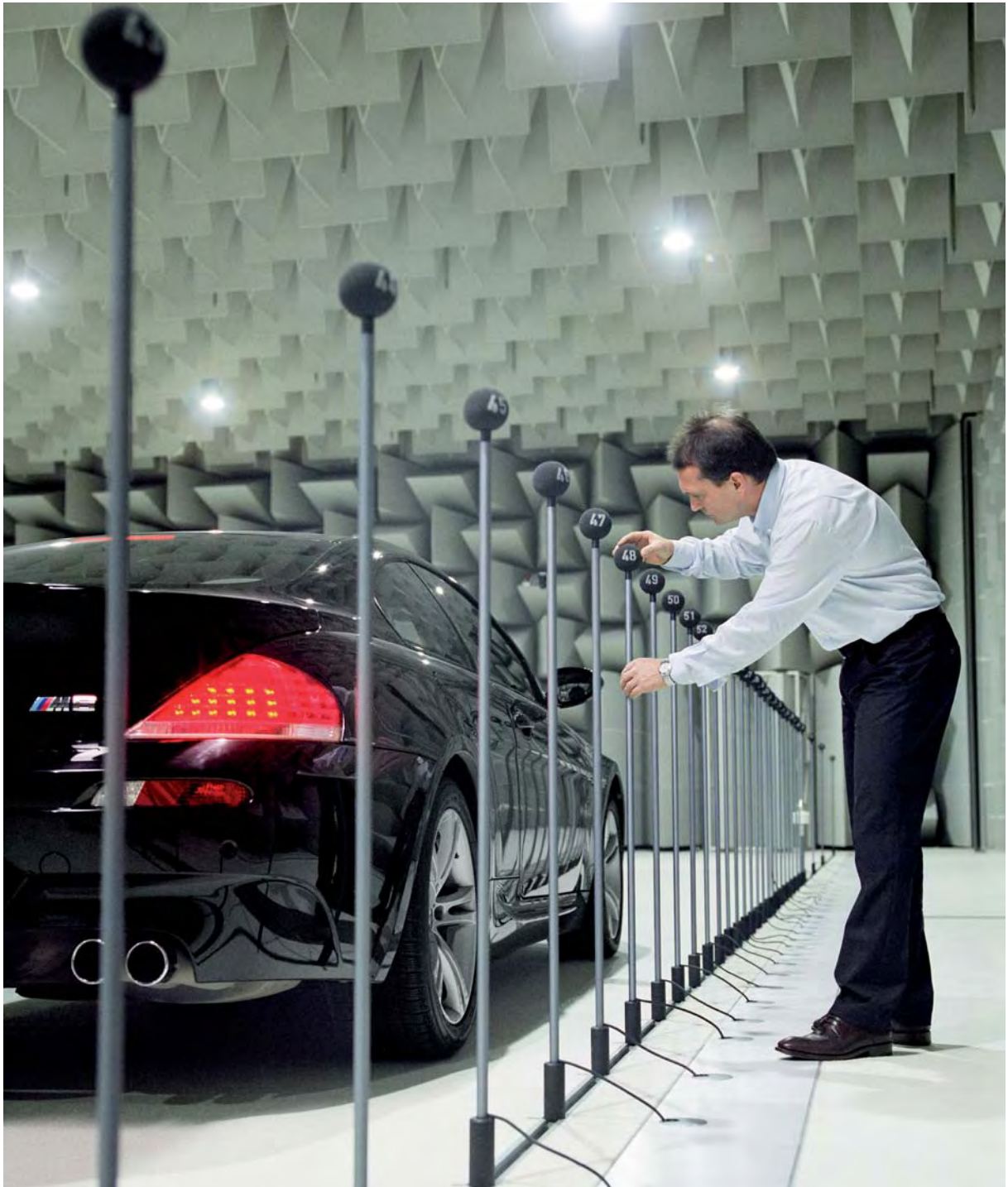

## 2.5

### How cars announce who they are

As well as the tactile and visual identities, a BMW must also have an extremely strong audible one. The noises in the cabin, from warning beeps to chunky door clunks, are all tuned in order to be harmonious, and to match the overall feel of the car. Drivers enjoy many auditory reassurances from their cars – the indicator tick, the “car alarm on” blip and the clunk of the door lock, for example – and these can be as telling a characteristic as a person’s voice:

“With my last car, the indicator stalk sounded like it was going to snap off. With this one it doesn’t – that’s a sign of quality. I like things to feel heavy. Feedback is good when a car is telling you it’s functioning well.”  
Male driver, 21, Hull

“I used to be able to name about 30 different cars by their exhaust note. Cars did sound more distinctive in the past. There are some lovely things – the door clunk, for example. My father-in-law’s car has a lovely indicator click, like someone knocking on a piece of teak.”  
Male driver, 35, South London

Together with engine tone, the exhaust note is probably the most emotive of all car sounds. BMW employs dedicated ‘sound designers’ to give each model its own engine soundscape, thought of as an ‘aural signature’ written within the ‘dialect’ of the Series, which in turn sits within the BMW acoustic language. Sound designers

deal with audible features such as the tone of the induction system, the ‘chorus’ of the cylinders, and the exhausts. Sound can be altered by changing the length of tubes, and while pleasant strains can be increased in volume by reflection, dissonance can be absorbed by acoustic wool placed in the exhaust system. The process can take weeks, even months, but there is no doubt as to its value.

Just the right amount of engine noise is deliberately filtered into the car’s cabin to reflect its individual character for the driver.

“A BMW M car is a highly emotional product. Every engine creates a unique sound experience that has to be an exact match for any given model,” Gerhard Hofstetter<sup>9</sup>, BMW Engine Sounds Designer on M cars, says. “The engine sound should make the driver’s spine tingle and make the hairs on the back of their neck stand up.”

---

01  
The sound of speed: Gerhard Hofstetter analyses exhaust notes at BMW’s Aschheim test facility

---

02  
Motorsport: BMW’s M cars offer sheer sonic exhilaration



## Chapter 3.0

### Sign of the times

"To make the Malhamdale wave, pretend for a moment that you are grasping a steering wheel. Now very slowly extend the index finger of your right hand as if you were having a small involuntary spasm. That's it. It doesn't look like much, but it speaks volumes, believe me..."

Bill Bryson, *Notes from a Small Island*<sup>1</sup>

"I might be unusual in this, but I like all that flashing your lights and waving stuff when you're driving. It reminds me of all those little signs you see builders using on sites when they are too far away from each other to shout. I don't like the flashing lights in anger obviously, but the little hand to say 'you go', or beeping the horn to say 'hello' – it's a bit like human connection overcoming the machine. I know you get road rage and so on, but to be positive about it, it's a way of people trying to get along most of the time, isn't it?"

Male driver, 41, Edinburgh

"I don't gesture too much or get too involved with other drivers. I laugh at people who gesture to me – they get quite wound up."

Male driver, 40, Helston

01

The co-operative society: driving involves sophisticated forms of spontaneous communication

### 3.1

#### The mobile society

Cars have made it possible for millions of people to easily travel distances that would have seemed unthinkable 100, even 50 years ago. However, the esteem for this benefit is often tempered by a sense of unease about the car making day-to-day life less communal, and more self-centred. Alisdair Aird's 1972 book *The Automotive Nightmare*<sup>2</sup> is typical in asking "Who, 50 years ago, could have imagined that we would sacrifice so much of our lives to motor cars?"

"When I look now at where I grew up, a little mining town, and compare it to when I was young there, the main thing I notice is the lack of people walking about. They would all be up and down to the shops or the pubs... now they live in the bubble of their house, leave it in the bubble of their car, park outside the bubble of the supermarket. It was the car that changed the way society works, more than anything else I'd say."

Non-driving male, 68, Sheffield

And yet driving on roads involves a highly regulated form of social civility. There are the Highway Code, road lanes and signs, and fixed and improvised gestures, and most of us follow the codes rigorously and with a high level of co-operation. This could be seen as indicative of an instinctive commitment to a version of 'society', where as 'social animals' we operate within a complex, highly collective and collaborative system of the roads.

In fact far from being a solitary and unsocial activity, driving is an activity full of language and communication and in this area, BMW technologists are fashioning some of their most radical ideas. Ideas that will, in the years to come, transform the way it feels to drive.

01

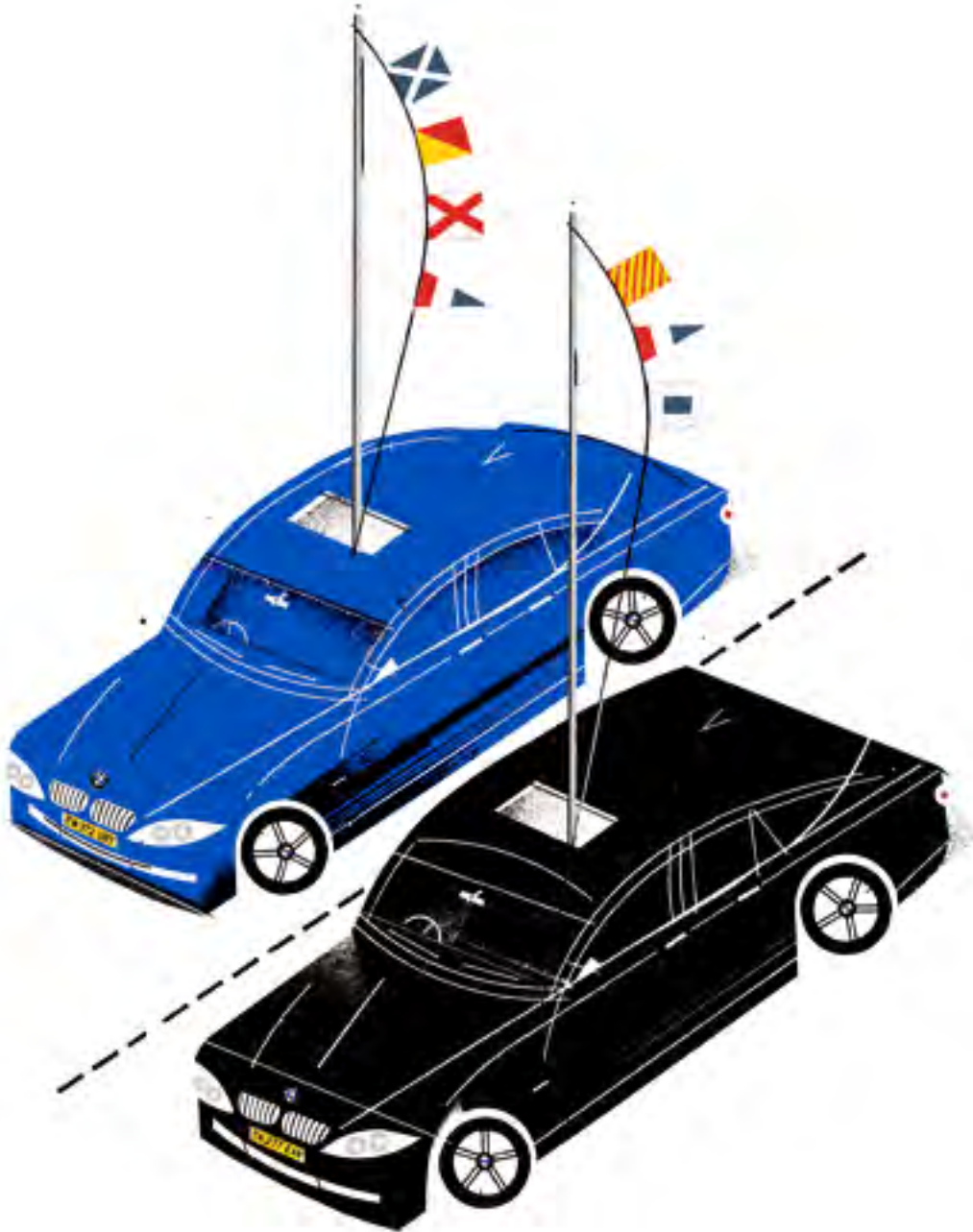



## 3.2

### Carmmunication: today and tomorrow

Beyond official road signage and hands-free phones, there are very few means of communicating with others at the driver's disposal: the lights, the horn, and the hand gesture. Given this basic starting point, the common usage codes that have evolved (using hazard lights to indicate sudden slowing and heavy traffic ahead, for example, or using shorter horn blasts to indicate friendlier intent) are quite remarkable. They are also relatively un-studied. The RAC<sup>3</sup> has recently noted the lack of understanding of these codes, and became the first motoring organisation to undertake serious research into the subject.

The range of commonly understood unofficial signals is too great to be given in full, but many will be recognised in the following quotes:

"When people flash their headlights, the faster they flash them on and off the angrier they are. One long slower flash I would generally interpret as a 'thank you' or 'you go', but the trouble is that it isn't always the same. For 'thank you' I would hold up my palm – between the two seats if I wanted to thank the person behind, further towards the windscreen if it was for someone coming towards me."

Male driver, 36, York

"With the horn, it's two or three quick beeps to say 'hello, I'm here', and long ones to say 'you idiot'."

Female driver, 46, Edinburgh

"There's a relatively new one, the double-indicator flash. Have you seen it? When you let someone in front of you, they sometimes alternate their rear indicators a couple of times to say thanks. I don't remember that always happening. I think it might have come in the late 1980s."

Male driver, 27, North London

If we define language as the use of patterns of sound and gesture (or body language) to convey information, then clearly we have an approximate, improvised language of sorts. In the future though, in-car technology will see our old-fashioned, inpromptu car-to-car technology radically superseded. Engineers at BMW ConnectedDrive are leading the way towards a world in which cars are linked by real-time wireless networks, allowing drivers to share information on traffic density, road conditions or weather. These technologies will amount to a whole new inter-car language, one that is more formalised and universal. A fascinating new chapter for car-to-car conversations is imminent. There's never been a better time to ask, then, what we say to each other and why.

## 3.3

### How you drive is what you say

Among our interviewees, drivers' attitudes tended to fall into three groups.

First, there were those who disliked and avoided the ambiguity of this informal 'carmmunication', well represented by this 35-year-old male driver from South London:

---

01  
Intersection super highway:  
when we drive we connect  
with society in a unique fashion

02  
Having a laugh: a recent  
April Fool's advert from BMW  
highlighted how difficult it  
can be to communicate with  
fellow drivers

03  
Mirror, signal, manoeuvre:  
unofficial sign language is  
bound up with driving

---

01



02



03



"I hate flashing headlights because it's ambiguous. Plus there are regional differences to that. It can mean, 'I'm here', 'come through', all sorts. I hate second guessing. There is often a failure of communication by people who sit behind the wheel of their car."

Secondly, there were those who saw it as functional but were indifferent:

"It can be useful. I like it when people try to intimidate me, because I just ignore them, and it's much more annoying to them, a good way to get back at them. And quite satisfying to you."

Male driver, 28, York

Thirdly – and this group made up about half of the total – there were those who at times or all the time relished all or certain aspects of it. There was a roughly even spread between men and women, but generally, and perhaps surprisingly, men were more eager to discuss it.

Among groups of this third type, several specific gestures generated good-humoured debate. Referencing Bryson's 'Malhamdale wave' (page 28) some drivers from rural areas found delight in how locals acknowledged one another with only a slight raising of the right index finger. Although Bryson identifies this with Yorkshire, drivers from other regions, particularly Cornwall, claimed it as their own. There was even some competitive comparing of lifts of the finger.

The origins of the double indicator 'thanks' gesture<sup>4</sup> appear to be something of a mystery, although several

drivers expressed differing beliefs. Some felt it had been around as long as any other signal; others felt it had become widespread only in the past ten years. All agreed, however, that it seemed to have come from the drivers of goods vehicles – indeed some people felt that all on-road signage probably originated with them. One logistics manager from Leeds pointed out that:

"It's lorry drivers who usually develop those signals out of necessity. But there has been a change over the past ten or 20 years because logistics has become a boom industry and as a result you have more lorry drivers on the road. In their cars they'll use the same signals they do when driving trucks, so you've got a greater mingling now, and the new ideas spread quicker. I suspect that's the origin of the double-indicator flash among motorists."

Headlight flashing was a cause for concern, as many drivers felt it could mean either 'go' or 'stop' in different circumstances; for this reason the Highway Code stresses that the driver should never assume it is a signal to 'go'. Some felt its meaning changed in different regions – a common theme, even leading to suggestions that certain gestures were particular to certain areas. Insult gestures were felt to be a potential area for serious misunderstanding, particularly when driving abroad:

"Someone told me that in Germany, if you make a ring with the index finger and thumb and hold it up, it is taken offensively, but if you do the same in Italy it is taken as a sign of excellence. I'll keep my hands to myself I reckon!"

Male driver, 28, East London

---

01  
Please and thank you: do driver gestures have regional accents?

---

01

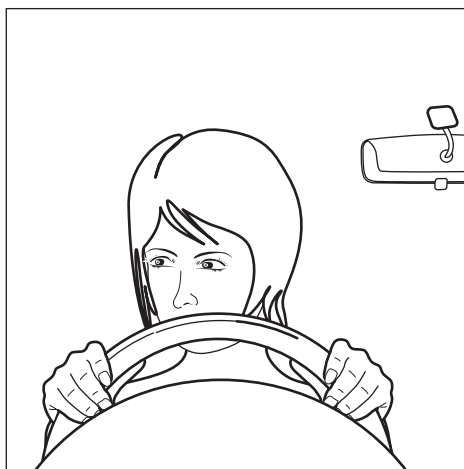

### 3.4

#### Sorry seems to be the hardest word

Communication between us and other drivers is rudimentary and open to misinterpretation, mediated almost entirely non-verbally with little nuance or expression. When failures in communication systems occur, feelings, at the very least, can often be hurt; road rage is commonly a result of poor communication or confused interpretation rather than of poor driving per se. Tellingly, when it comes to the message drivers would like to express but cannot, most said it was 'sorry'. They noted there is no agreed gesture to say 'sorry' or 'I didn't know' after making mistakes, and that there is no means of expressing upset at not being thanked.

"A lot of people drive with the attitude that everyone else is trying to rip them off. It's about an awareness of other people around you. There is no way of saying, 'Sorry, I didn't know this lane was for right-turns only, when I wanted to carry on straight.' I would like to be able to say, 'I didn't know.'"

Male driver, 38, North London

Several drivers noted that there existed accepted thank-you gestures:

- The rear-indicator wave: 'Thanks for letting me pass'
- Flashing the headlights: 'Thanks for letting me through'
- Lifting anything from one finger to a whole palm from the steering wheel
- The touch-of-the-brow salute

- The palm held up. When held up for the driver behind, this is an unusual gesture in that it is made to someone the gesturer may not always be able to see

The most common form of indicating apology, based on our observations of actual driving, is the up-raised hand, similar to the thanks gesture. Of course this leaves scope for ambiguity. Driver A erroneously pulling out in front of an oncoming driver B is likely to compound B's annoyance by effectively suggesting that they had indicated for A to pull out like that. Perhaps it was for this reason that some people we observed using this gesture did so with a duck of the head and holding the hand high, as if genuflecting.

All of which is important. Courtesy may not be vital to the task of getting from A to B, but many drivers find a lack of consideration for others on the road aggravating – symptomatic, even, of a broader decline in social awareness:

"My dad told me how polite the English were – he learned it in Calcutta – and instilled gentlemanliness in me. I'm horrified how some people just genuinely don't get basic etiquette. None of this is in the Highway Code. For example, if an obstacle is on your side of the road, it should be you who pulls in. But people don't."

Male driver, 35, South London

Much inter-driver signalling – the flash of the hazards or the headlight to say 'thanks', for example – depends on a context-bound signalling which uses the formal

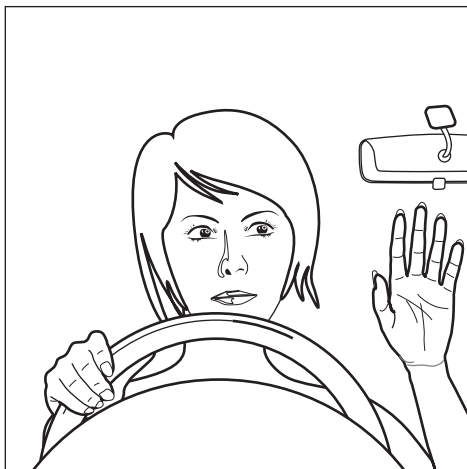

functional signalling system such as hazards and headlights in the name of the 'human' touch/sign. Drivers' goodwill messages piggyback on the normal functions of hazards or headlights in order to convey context-specific messages. These messages might be inessential, but they are crucial in affirming the shared community of driver-souls – the 'car Karma' as one respondent had it. In effect they are a common law linking 'good' reasonable drivers and good driving with the shared rewards of hassle- and angst-free journeying.

### 3.5 Constriction and brinkmanship: when language breaks down

Driver communication difficulties can arise quickly at a bottleneck where one driver must defer to another. An obstacle such as a parked car blocking one lane of a narrow street road can produce reactions from pushiness and arrogance to violence. This event – along with lane-hogging, overtaking on motorways and vying for a free parking spot – is where effective communications between cars are required, but routinely found wanting. Confrontation can quickly result:

"The route I drive to my childminder has two lanes that go into one at four points. In two you have priority, and at the others, they have priority. There is always a standoff. I can't be bothered. This is in South London and there is a way of London driving that people who're not from London think is like, 'whoa!'. You push the boundaries a bit and arguments can happen. I don't argue with some people, especially if he's a young bloke."

Female driver, 40, South London

A fascinating form of brinkmanship often results from these situations. We observed drivers yielding to one another at bottlenecks in Leeds, Brighton and London, and also asked our interviewees about their experience of the process. The difference of opinion, and comparison between recollected experience and actual events, was striking.

One of the most intriguing contrasts was between the drivers of larger, more prestigious cars, and those who had smaller, less expensive makes. The former group tended to be adamant that larger cars received deference from lower status ones, as one saloon driver demonstrated:

"I'm telling you, you go up against a little hatchback with a big new saloon, the hatchback's going to give way every time. They think it's more powerful than them."

Male driver, 39, York

However, one driver of a smaller car felt the opposite:

"No one lets big expensive cars in. You don't want to let them get their own way all the time, do you?"

Male driver, 37, Edinburgh

And, crucially, they were less likely to be concerned:

"Who on earth cares? If they want to get through that badly, let them."

Female driver, 37, Hull

---

01  
The nod and the wink: in a  
squeeze friendliness can work  
wonders

---

02  
The back hander: a small  
gesture brightens the day

---

01



02



It appeared from our observation that the reality is more complex. It is true that longer (though not higher) cars are deferred to by shorter ones, but this is not dependent on prestige; it is common to see a newer, more expensive small car cede to an older one with a longer bonnet. When cars of greater prestige took precedence over lesser ones, it was not because of the latter yielding so much as the former moving more aggressively into the available space. It was noticeable that higher prestige cars tended to be readier to admonish smaller cars with toots on the horn. All this confirmed the opinion of an interviewee who worked as a luxury limousine driver while running a small hatchback in his private life.

"When the traffic builds up, people don't tend to let bigger luxury cars in. You have to muscle your way in."  
Male driver, 64, West London

It would of course be wrong to think that all smaller car drivers are yielding; many behaved in very assertive, even aggressive, manners.

Perhaps most interestingly, most yielding takes place between cars of similar size; the drivers who do give way to large cars are the drivers of other large cars. This is generally true across the board; vans are likely to help out vans, lorries help lorries, and nippy hatches help other nippy hatches. There is also a discernable tendency for women to let other women out, although since women tend to drive a narrower range of sizes of car, it is difficult to judge whether this cuts across the apparent empathy between vehicle types. What

was clear was that at busy roundabouts, female passengers often help male drivers by offering advice as to where they are going and looking to see if the road is clear.

In order of importance, there were five factors that appeared to determine whether or not drivers would be 'let out':

- 1 Similarity of vehicle
- 2 Relative assertiveness of drivers
- 3 Relative length of vehicles
- 4 Gender of driver (women tend to yield more)
- 5 Age (older drivers tend to yield more)

### 3.6 The talking BMW

It is with regard to stressful and conflict-prone situations such as these that BMW is developing technology that will in future help to reduce misunderstanding and miscommunication, leading to more enjoyable driving and less danger to drivers.

Some of these BMW innovations are relatively straightforward. For example, Brake Force Display – brake lights that burn brighter in response to braking harder – represents a step towards improved car-to-car communication that also minimises a risk of confrontation in instances such as an emergency stop. But the company also proposes further, more radical solutions

---

01  
Happy talk: car-on-car  
communication will improve  
your journey

---



that involve a futuristic principle: making cars talk to each other and share each other's information.

Take, for instance, a situation in which a car has been left blocking a road. In future, technology will allow a passing car to feed this information into the satellite navigation system and route the driver round the obstacle without risk of confrontation.

BMW's ConnectedDrive project going forward aims to connect BMW drivers and their cars to the road and other BMW drivers – enabling cars to create an internet-like grid sharing information through wireless technology. "Our vision is to have cars talking directly to one another," Timo Kosch, BMW Vehicle Communications IT Project Manager, says. "The technology provides information on what other cars are seeing or hearing with sensory technology. It means that cars ahead can stream to you real-time information about the traffic density, say, or if it passes over a patch of black ice or through rain. That will allow a new, co-operative way of organising traffic. It will empower drivers to choose the best route, and change the patterns of traffic on our roads."

Rather than absolving the driver of responsibility, the programme aims to actively empower the driver by simplifying communication. "ConnectedDrive is not about turning BMWs into automated vehicles," Kosch adds. "In a BMW, the drive experience is everything. What we want is to free the driver to drive."

BMW Assist technology already begins to provide this.

In the event of an emergency the SOS function can be operated manually and if the airbag is deployed it will automatically connect the driver to the emergency services. In addition, a driver can select to be connected to a BMW operator providing business listings.

### 3.7 And they talk to us too

One of the most important and radical areas of design in the 21st Century will be based around artificial intelligence and communication between humans and designed objects and machines. The idea conjures images of an alien, robot-filled future, but the reality will be different; the more successful this sort of design, the less we will notice it and the more it will blend with our self. In Japan, the design company SGI has created a technology called RoomRender<sup>®</sup> that allows sensors in a room to notice the emotion in your voice, and set a suitable ambience with music, aromas and lighting, while designer Caleb Chung<sup>®</sup> has built a chair that responds to the emotional state of those who sit in it.

The principle creates fascinating convergences of design, therapy and art. In Doetinchem, in the Netherlands, these principles have been enshrined in the D-Tower<sup>7</sup> – an interactive sculpture in the centre of the town, which glows in a different colour in response to the mood of the townspeople, measured by an online questionnaire.

BMW has led the motoring industry in exploring these

01

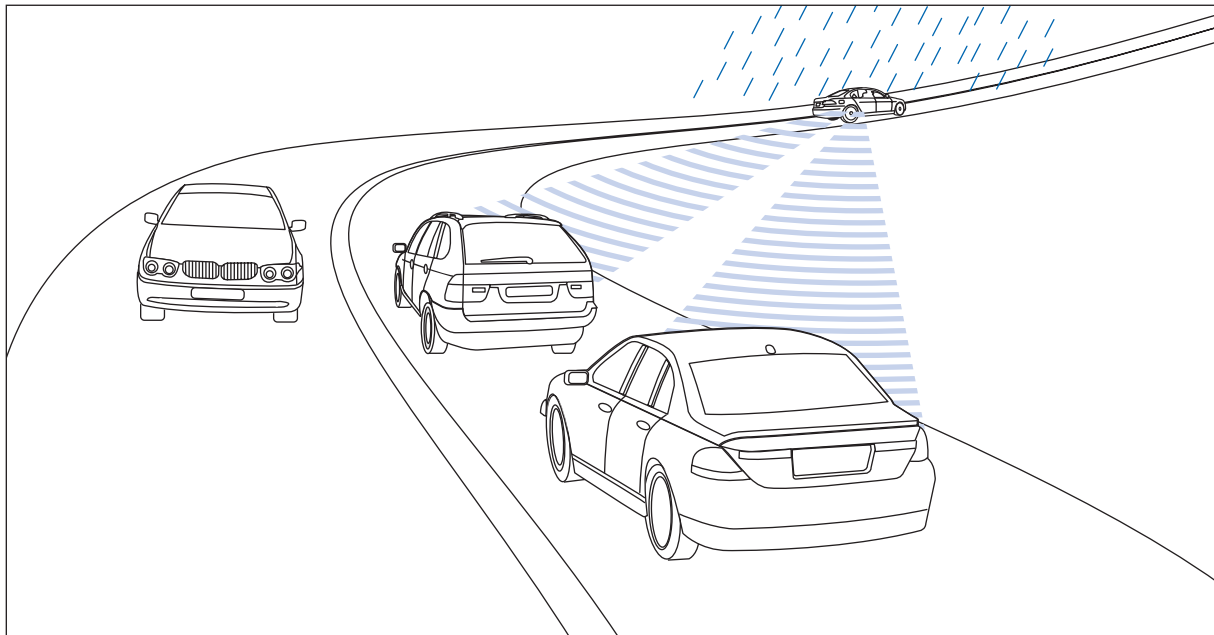



01

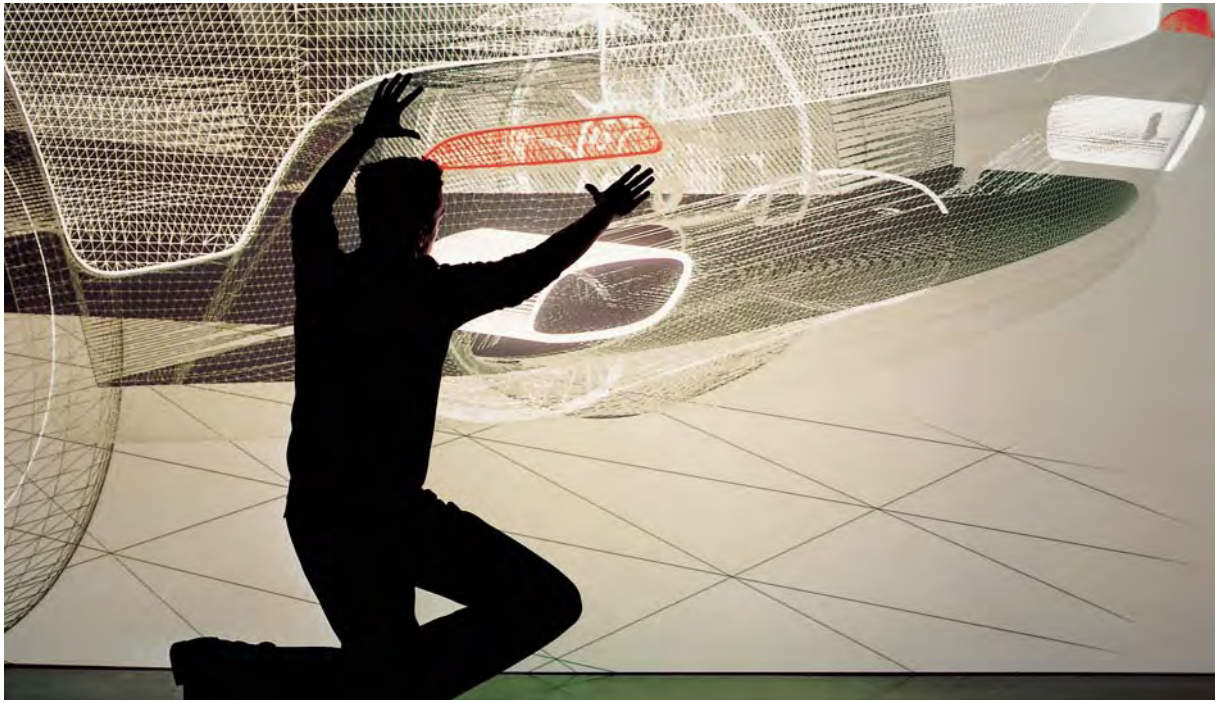

areas and their potential for driving. It was, for example, one of the first car manufacturers to offer in-car speech recognition technology. Currently, the system uses a fixed vocabulary system, in which the in-car computer is able to recognise words controlling about 80 per cent of the iDrive functions allowing the operation of functions such as phone-book and navigation through voice commands. Limited commands such as "call John Smith" are possible. Speech recognition truly comes into its own when drive workload is high. "We want the car to behave as an intelligent friend," says Dr Frank Althoff at BMW Driver Interfaces Management.

In future, BMW engineers hope to move towards an understanding of more natural, intuitive kinds of speech. Dr Althoff says, "Instead of saying, 'climate, heating, on, downstream', we want the driver to simply say, 'my feet are cold'. We're looking for really intuitive, natural communication between driver and car."

BMW aims to improve speech recognition to a closer and more emotionally intelligent bond. "The car will understand not just what you said, but how you said it," he adds. "We can analyse pitch of voice, volume, and intonation, to build a picture of driver emotion. Is it positive or negative? The car will know and respond accordingly. Say you're asked if you want to receive a call, and you say "no!" angrily. The car will know not to ask you again for a while."

Voice control is only one of many ways in which a BMW communicates with the driver. Take the Head-up Display (HUD) units which solve a particular communication difficulty – ie, drivers focusing on the road ahead at the same time as being alert to their own car. Research shows that continual refocusing of the eye between instruments and road is a major contributor to drowsiness.

BMW's HUD projects speed, cruise-control and navigation directions into the driver's line of sight, enabling the driver to appraise data without taking their eyes off the road, reducing strain on the eyes. BMW is now experimenting with a RoadPreview element of the HUD, which will display information about the road ahead.

"The Head-up Display is about empowering the driver and removing distractions," says Martin Ertl, BMW Innovations Manager.

"Whenever we can keep the driver focused on the pure driving experience, that's what we aim to do."

Haptics – interactions involving touch – are playing a growing role in driver-to-car communication. BMW's iDrive controller, for example, was engineered to provide a nuanced tactile feedback. "With the iDrive controller, you have to use a little force to use it, and whenever you turn it you hear a little click," Ertl explains. "Haptic feedback is crucial." Other BMW haptic innovations include Lane Departure Warning system: where a vibration in the steering wheel warns the driver if they drive over a white line without indicating, signalling to the driver that it might be unsafe. An audible warning would be more likely to cause an over-reaction or alarm passengers.

### 3.8

#### Gesture – and emotion – recognition

Cars are now responding more sensitively to their owners' commands than ever before, then, but in the near future communications between car and driver will become intuitive; the car will recognise its driver's voice, gestures, mood and even emotions.

"We see a future in which our cars will become more and more intelligent, until they are able to respond to us as a friend does," Professor Raymond Freymann, Head of BMW Group Research and Technology, says. "A car that can effectively predict and understand its owners every mood or switch is a long way off, but BMW is progressing towards multi-modal communication".

Gesture is a fast-developing area. BMW has studied human gesturology by conducting tests, in which around 50 volunteers sat in car mock-ups. The volunteers were asked to perform regular tasks as naturally as possible using gestures. A clear picture emerged of several powerful human gestures that seemed universally understood, and used, including a nod and a shake of the head; a 'wipe' of the right hand sideways either towards or away from the body. They were then incorporated into BMW gesture-recognition technology. A telephone call, for example, will be accepted or declined with a nod or shake of the head. Music tracks can be skipped back and forth with a swipe of the hand.

Rather than exploiting these in isolation, they are integrated into a broader driver-car conversation. We use these gestures and the voice continually in everyday life. Now, the BMW will be speaking your language. "Voice and gesture recognition are all just pieces of a bigger puzzle," Dr Althoff<sup>®</sup> says.

"The overall aim is to create cars that allow us to communicate with them in a way much closer to the way we communicate with each other. That means not using single information streams, but lots of streams at once. Emotion is part of the driving experience, so it should be studied. There is a new kind of drive feel if the car understands you in a very intuitive and natural way. You're less distracted, and you feel a new kind of freedom to enjoy the drive."

In this sense, an understanding of the real human joy of driving has only really just begun.

---

01  
Communication: the Head-up Display enables vital data to be read without drivers taking their eyes off the road

02  
Small gestures: in the future your car will be able to understand your hand movements

---

01



02



## Chapter 4.0

### Work, rest and play

"We normally have quite a laugh on the way home. Or we discuss... we normally have quite a lot of conversations and make decisions about things and it's just dedicated time. You can't go anywhere so you may as well. I mean we've probably decided on a lot of things we've done while driving so I'd say it's a good thing. Whereas before, when we used to get the train in to work you'd rarely end up on the same train home and even if you did you wouldn't want to talk about money or have a row or something... So I think it's an excellent place to get things sorted out. I like it a lot actually."  
**Female driver, 32, Maidenhead**

"The car is like an armchair, and it feels more like home than an outdoor environment. It's a very nice thing to be in."  
**Male driver 42, South London**

"We're constantly asking the question: what kind of psychological space is a car?"  
**Klaus Bengler, BMW Driver interfaces Psychologist**

---

01  
 Join the dots: navigation has transformed the driver experience and has put its own unexpected spin on human relationships

---

#### 4.1

##### An intelligent friend

What kind of psychological space is your car? Or, to put it another way, when you're in your car, where is your head? Over the last decade, we've seen a profusion of new in-car technologies that have transformed the possible answers to this question. These technologies have created new driver behaviours, and allowed us in-car capabilities that once were the stuff only of dreams.

Of all the technological innovations installed in cars in recent years, satellite navigation systems have been among the most transformational – they have altered driver behaviour to the extent that some drivers cannot now envisage driving without it. It would be strange to consider a parallel innovation for hikers and outdoor sports participants – the handheld GPS system – being used, for example, to navigate through the shopping areas of central London. Yet it is common to see drivers sitting in a traffic jam in their home town consulting their navigation devices.

What navigation brought to the car was more than just the ease of knowing where to go. It brought a change in relationships between people in the car – particularly between men and women, husbands and wives. Reducing tension over map reading, for example. Interestingly, the large majority of men, when they have a choice of either a male or female voice in their satnav, choose the female option and vice versa.

Harmony is not always assured, however. There have been incidences of 'nav rage' in which irate drivers have lashed out at their coldly functional computer personality:

"The voice gets on my nerves. I have it when I need help, but when it says 'stay on this road for the next 58 miles', and then says 'stay on this road for the next 48 miles', it's pointless and annoying."  
**Male driver, 40, Derby**

01

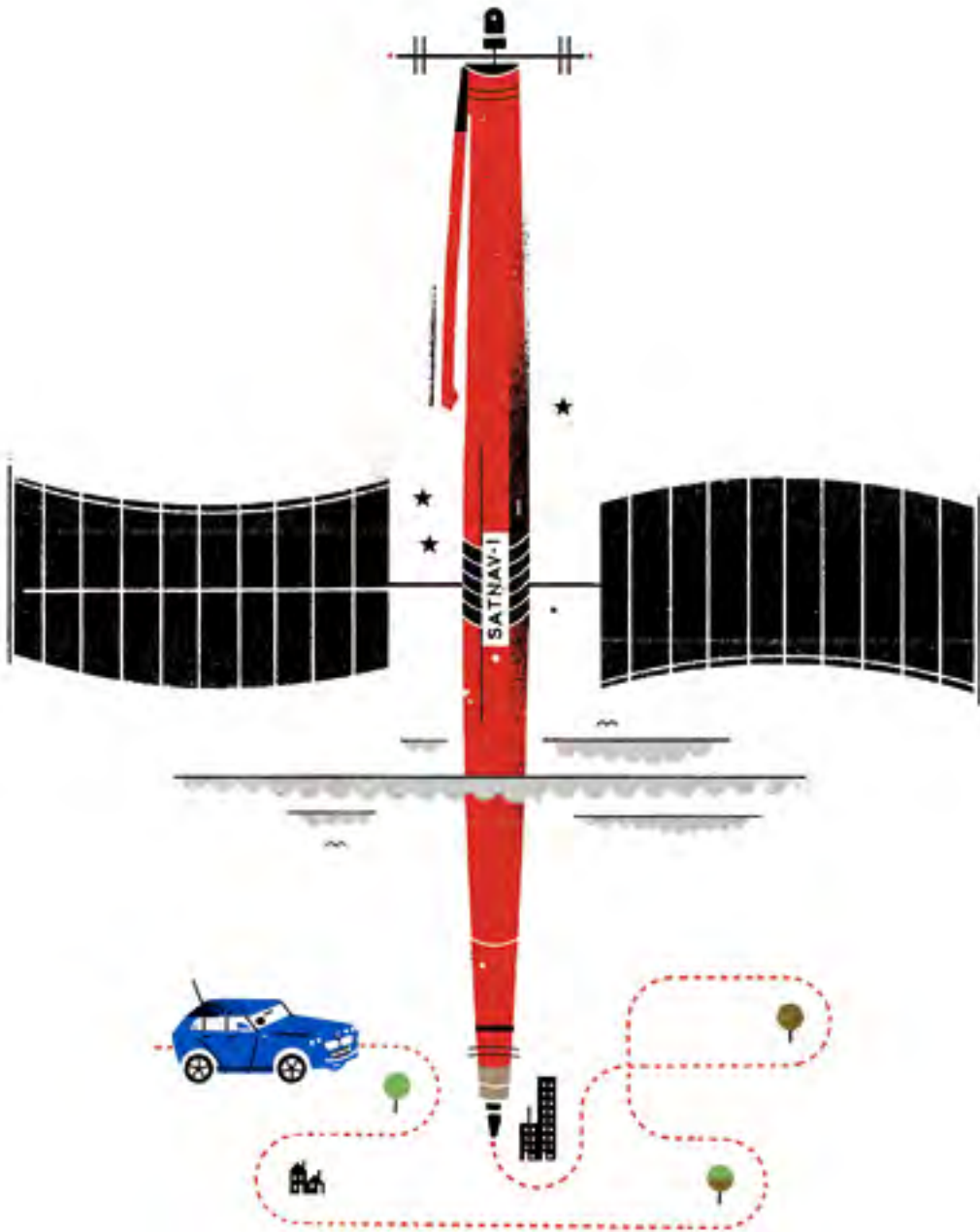



But BMW research underway in Munich aims to reduce such problems, by making driver information systems that are attuned to the driver, not only in terms of his or her preferences, but also in terms of their mood.

"The idea is to have these kind of systems where it's like a person sitting next to you who you just ask, and they provide the answers for you," says Timo Kosch, BMW Vehicle Communications IT Project Manager. "It is in the future but we are working on this. If you knew the route of the driver, you could adapt the way you are providing the info. You could even think about adapting the voice of the navigation system so that it answers your question according to the mood you are in; so it might react in the way a human being would. Perhaps it would calm you down if you are cross, or try to be funny if you are bored or frustrated."

Other technologies, too, have transformed the kind of space we are in when we drive. The car has become part of today's restlessly connected world, and a raft of BMW features now help those 'in-car' reach out to the world beyond. Take BMW Online, for example, which sees drivers now able to find restaurants and hotels from their car, or check the weather, or stock market information. Meanwhile, BMW mobile office facilities mean you will never be stuck for a name, or a number, again. No wonder, then, that today, for many, the car has become a vital space from which to keep in touch with work colleagues, family and friends.

Other new technologies, meanwhile, are busy transforming the connection we make with our cars, and, so too, the experience we have when we drive them. Is the car becoming the perfect space in which to enjoy solitary, blissful 'me time'?

Professor Raymond Freymann, Head of BMW Group Research and Technology, explains that BMW is working to build cars that can respond to the emotions of their drivers: stress might be indicated by steering or braking, or tone of voice, for example. "In such a situation, say, if the driver was very stressed, you might not let a phone call come through. Leave it, let him do his work, and let the phone call come through later. Or perhaps the computer would detect certain things, such as respiration rate, and change the music and lighting if it sees he is becoming stressed."

In the more distant future, BMW cars may even help manage driver's moods and wellness, using technology that interacts with biology. Interior LED lighting can already create a warming orange glow but planners and interior designers are discussing the use of light to positively stimulate the senses to create a sense of calm in cars. Further developments at BMW include testing the circulation of salted air through the air conditioning to help ease breathing. This is in keeping with Philips' new ActiViva<sup>1</sup> lighting systems, a lamp range producing light that stimulates receptors in the eye to boost energy and wellbeing.

---

01  
Night rider: the central console provides a guiding hand

---

02  
It's good to talk: many couples consider car journeys to be the best time to catch up

---

01





## 4.2

### Driving dialogue

Car interiors provide unique cocooning spaces not only for drivers, but also pairs and groups of people. More than half of the male-female couples we interviewed said some of their most meaningful and intimate conversations took place inside their cars when they were driving together, and some even said they had gone for drives with the express purpose of talking about a problem or making plans.

Indeed, a few mentioned that they often had arguments in their cars, but suggested that this was a good place to have them. Arguments between couples can occur in the enclosed space of the car for several reasons. Traditional tensions surrounding dominance and control surface, there is no 'escape route' and in the free time of a long drive, couples may feel able to confront issues:

"My girlfriend and I have a lot of arguments in the car – none of them to do with driving. You can't walk out of the room or go into the garden. There's no escape. It's easy to resolve those. We sort it."

Male driver, 38, South London

"With my wife and I it can be about map-reading and directions, that sort of thing. But also the car makes it easier to talk about things, if you live in a flat or a terraced house where people can hear you talking. You're enclosed in the space and can speak your mind."

Male driver, 35, Nottingham

But in-car communication doesn't always centre on personal relationships. Research into work relationships generated some unexpected stories about car experiences from our interviewees. Friendships between men at work, for example, could sometimes seem to rest solely on conversations about their cars:

"My boyfriend says the blokes he works with talk about nothing else but cars. Well, maybe about sport a little bit, but they fall out about that so mostly it's cars. He gets fed up with it, because he doesn't drive."

Female driver, 36, Hull

But the most amusing experiences centred around bosses. Typically, these focused on their bosses' tendency to undermine the feelings of self-reliance and empowerment that drivers cite when alone at the wheel. Our respondents referred again and again to journeys to and from business meetings. They also tended to involve directions:

"I love driving but in my old job I used to have to drive my boss when we went to meetings together. She would always comment on the state of my car and then she'd complain if I got the directions wrong. The thing was, I never used to get them wrong on my own – she made me so nervous."

Female driver, 48, Glasgow

"When the boss got a car with satnav we all breathed a sigh of relief – make a mistake with a map and you were in trouble."

Female driver, 38, Oxford

02



But today, connectivity technologies have revolutionised communication in our cars. Where once we could talk only to those sitting with us while we drove, today physical distance is no bar to in-car conversation. Thanks to ConnectedDrive features – which aim to connect driver, car, and outside world – BMW drivers might find themselves talking to far away loved ones, holding impromptu business meetings, or booking hotel rooms. Research shows that, for many, the car is above all else a space from which to communicate:

"On the way to the office every morning, I call ahead to hear about any breaking issues that might influence the day. I work in a fast-paced environment, and that's a really important call. Then, I use a lot of the evening commute to call clients. It's only recently that the technology has become reliable enough for me to feel confident making business calls from the car. But now that I can, it means I use the car as a place to wrap up the day, so I don't have anything to do when I get home."

Male driver, 37, East London

### 4.3

#### We are family

In many of our conversations it became very apparent how much the car has become an extension of our lives into the public sphere and this seemed particularly telling when it came to discussing family driving.

For many families, a car journey of three hours or more will be one of the longest periods of time they spend in each other's company all year. Some respondents pointed out that as a communal experience, it is probably more common than the now semi-mythical 'family mealtime'. The enforced togetherness could be stressful:

"Getting a four-person family in a car is like moving a small army. When your natural position is in front of a TV screen or computer terminal, the idea of spending hours in a metal box becomes unappealing, so the kids are grumpy. Then there's the endless loo visits – you know, kids decide to go just as Dad is pulling away, then Mum goes in sympathy, then dad decides he may as well go as well."

Male driver, 42, South London

Even short trips can be fraught with logistical complications:

"Shopping is a right pain – you've got the trolley, bags to unload and inevitably I won't have a clue where my keys are."

Female driver, 36, Nottingham

Thankfully, BMW is on hand to help with this particular predicament. BMW Comfort Access means the key need only be on your person to open or lock the door, or even start the engine. Once on the move, the long-haul family car dynamic becomes quickly compartmentalised into a series of different environments:

"Children do not, as a rule, look out of the window for anything. You could be passing Stonehenge, Buckingham Place, the Taj Mahal even. Instead they want to make the car, as much as they can, an extension of their room at home."

Male driver, 42, South London

01



Headphones, headrest screens, mini LCD screens, iPods, mobile phones; these items may be fun to have around in day-to-day life but they have positively revolutionised family car travel. A long journey for the average family, may find Dad fiddling with the satellite navigation, Bluetooth attachment to his phone plugged into his ear, mum answering emails on her BlackBerry, one kid on a Nintendo DS, another grooving to her iPod, a third watching a movie.

This could be, and was by some, seen as a bleak image of family life – but rather tellingly, scarcely anyone who had undertaken long drives with children felt this was the case. And it should be pointed out that many of this latter group had had many blissful moments:

"I had a wonderful automotive moment very early on a long drive from London to Ibiza. It was late afternoon. The weather was clear and warm and the Normandy roads were all but deserted. I was in a very comfortable, very safe, rolling box with my wife and two children, in a beautiful country with no immediate plans to go anywhere particular or do anything specific. Our car, a nice and fast but commodious tourer, was packed full and running cool, quick and quiet. We were a happy and efficient self-contained family holiday unit. Beats flying, I said to my wife. She paused and looked back at the kids, their intense little faces locked on to their little screen, and she nodded her agreement. I was almost deliriously happy."

Male driver, 42, South London

#### 4.5 Know your place

There is a great deal of unspoken family etiquette governing seating positions. Generally men assumed first refusal on driving, and the rest of the seats tended to be occupied by the same family members whatever the occasion; some people spoke of a sense of strangeness if one parent sat in the back, for example.

"The children see the back seat as their domain; they don't want to be in the front because the bench seat offers more potential for lounging and the arrangement of their stuff. They love pillows and blankets and sunshades – anything to make the car more homely. I think the fact that mum and dad always have their backs to the kids gives them a psychological advantage; more potential for unseen misbehaviour."

Male driver, 38, East London

Almost everyone who had brothers or sisters had a story to tell about the seating positions they had to endure when they were children – usually these were stories told with a sense of injustice.

"I was the only girl with two brothers. I always had to go in the middle, the least comfortable place with no room. They would deliberately spread their legs out so that I would have to sit all squashed up. It was totally unfair."

Female driver, 26, Edinburgh

01  
Watching the English: the politics of couples in transit

02  
Pole position: the single handed approach to steering seems increasingly dominant

01

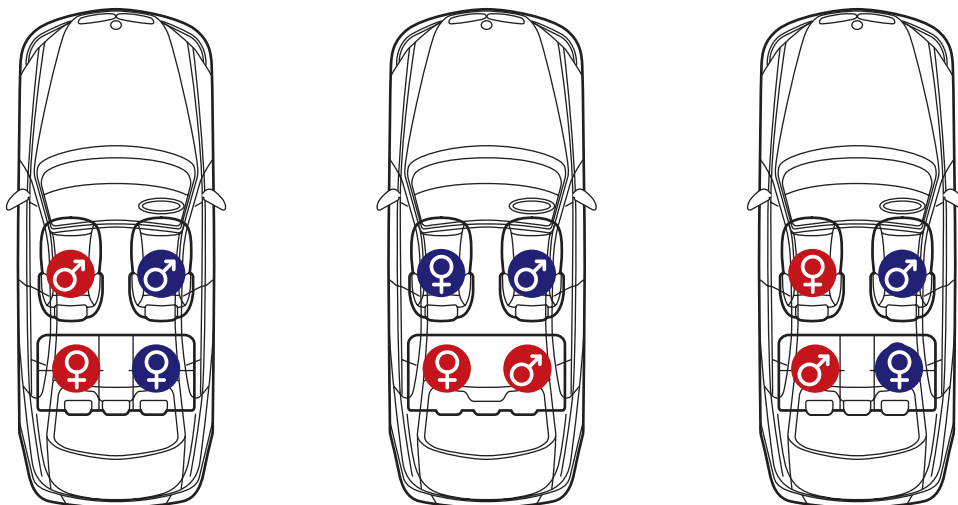

"The worst place was behind dad, because he had his seat pushed quite far back. You had to sit with your legs to one side – Very annoying. Of course, I now do the same thing."

Male driver, 36, South London

But as one respondent pointed out, seating rules can apply beyond the realms of family life and can be particular to a nation – and as is often the case, it takes an outsider to identify such:

"My American friend sent me a description of where English couples sit in cars. It made me laugh because it's so true. It said with a working class couple the two men sit up front and the women behind. With a middle class couple one couple sit in the front with the man driving and the wife in the passenger seat. And if its an upper class couple the couples mix up so one man drives and the other man's wife sits in the front. Genius."

Male driver, 45, Leeds

#### 4.6

##### Rituals of separation: assembly and disassembly

If the car is a special psychological space it is, ultimately, of course, because we make it so. When we step into a car, we automatically seek to connect to the new space in which we find ourselves. But how? There is a process of engagement with the machine – we assemble

ourselves: our cup of coffee, our hands and feet in alignment with the mechanical and environmental features we need to use, or wish to use. This is quite unconscious – or at least shrouded from detailed reflection by its habitual nature.

And yet, when we get in the seat there is in evidence a deliberate ritual of engagement with the car. This is in part mechanical; the movement of handbrakes and sparking the ignition; the checking and adjustment of gears etc. But it is also a quasi-biological engagement; as we adjust seats and controls – heating, sound and light – to tune into emotional and affective preferences. In the modern BMW, of course, this engagement is affirmed by the car as it 'recognises' us: the seat conforms to our specific settings and 'remembers' our favourite destinations – and where 'home' is. BMW's Key Memory is the embodiment of this idea.

Close observation of drivers seated revealed remnants of these contraries in bodily alignment. In some cases one arm would be relatively taut, on the wheel and ready for action, the other hanging loose, barely touching the wheel, or idly scratching a chin, or drumming on a nearby surface.

In a different observation exercise, this time with the observer watching traffic from beside various roads and noting drivers' self-positioning, we found that more than 60 per cent of drivers drove with one hand. Men, being generally larger/taller were more likely to sit further away from the steering wheel, and to stretch their arms and legs. More women and older drivers drive with hands in

02

In percentage terms, the activity with the non-driving hand was as follows\*:

	Men	Women
Resting on gear stick	46%	31%
Held in lap	27%	39%
Smoking	6%	8%
Touching face	7%	6%
Resting elbow on sill	6%	5%
Eating	2%	3%
Other*	6%	8%

Figures based on drivers whose non-driving hand was visible.  
\*Gesticulating, reading, cleaning glasses, touching ears

03





the ten to two positions on the top of the steering wheel; almost 15 per cent drove with both hands holding the wheel at the bottom.

Ernst Assman, BMW Interior and Ergonomics Manager is responsible for the creation of car interiors that invite seamless, and pleasurable car-driver connection.

"In a BMW, the most important seat is the driver's seat. Whether it's a 7 Series or a 1 Series, in a BMW the driver always has the same amount of room. Driving is about feelings; the feeling of the suspension, of the steering wheel, of the car. First, it's our job to make sure that your posture in the car is good. It has to be comfortable, pleasurable, BMW-like. Then you can enjoy the driving experience."

[Ernst Assman, BMW Interior and Ergonomics Manager](#)

Observing drivers in BMWs, we noted that the seat and the feeling of space around the driver when well set invites real engagement:

"Yesterday, getting into the BMW, the coupe, I only sat in the driving seat, I didn't drive it and I'm not an experienced driver but I did feel like I could drive this car, and I wanted to drive it."

[Female driver, 24, London](#)

What's more, the car seat has to cater to a certain contradiction. Driving is unique as a human activity in that it requires a seemingly contradictory alignment of the body and psyche. On the one hand we need to be

highly alert, mobile, and vigilant. But at the same time we need to be relaxed, to sit back, to be held by the car. We are still and moving; alert and sedentary; in fight-mode and potentially in flight mode.

Of course, new technologies have transformed the way we connect with our cars, and the way they respond to that connection. In our research, although some were quite happy with the degree of automation in the cars, a few of our test drivers felt a sort of loss and discomfort with the ways in which technology allowed them to give up clutch control, gear changing, and various braking and speed management functions.

They appeared to feel protective of their driving skills and anxious that the delegation of these powers and skills represented some handing over of control to the car. This was not to do with the functionality of these car management systems – they make driving 'easier' – but about a reluctance to hand over too much, and a discomfort with the new bodily and emotional alignments that such a handing over seemed to entail.

"At BMW, we are constantly looking at the way drivers use their cars, and what they want from them. What we find is that if drivers are in an unknown place, or in difficult road situations, then yes, they may want technology that supports them. If they are free to drive, then we should leave them alone. In a BMW, the drive is always paramount."

[Klaus Bengler, BMW Driver Interfaces Psychologist](#)

---

01  
Take your seats: for BMW driver orientation is the focus

02  
Good vibrations: driving music takes on new dimensions in the 21st-Century

---

01



All the drivers often affirmed the importance of 'feel'. This word, referring to a range of functions (acceleration, braking especially) was cherished because the proper attunement of mediation between man and machine is intrinsic to the comfort of the driver in the car.

#### 4.7

##### Thank you for the music

Of all the pleasures we experience in cars, perhaps the most celebrated is listening to music.

"The stereo's the first thing I check out in the car. The drive home from the garage listening to the radio is like the first time you drive after passing your test."

Female driver, 33, South East

Curiously, more British drivers (64.8 per cent) listen regularly to music in their cars than in any other country in the world<sup>2</sup>. So what sounds do we like? A slew of compilation albums and magazine features attest to the existence of quintessential driving music, and a familiar list of songs repeatedly top polls of the best 'driving music', including: Queen's *Don't Stop Me Now*; The Jam's *A Town Called Malice*; Phil Collins' *In The Air Tonight*; ; Boston's *More Than A Feeling*; The Cars' *Drive*; Steppenwolf's *Born To Be Wild*; and Meat Loaf's *Bat Out Of Hell*.

Is there a formula for the driving classic? Not really. As one of our interviewees Jamie Salisbury<sup>3</sup>, a popular songwriter points out, they all tend to use open fifth (commonly known

as 'power') chords; to have strong "step-wise" bass movement, ie bass lines that move dramatically up and down scales; to fill up the sound-frequency spectrum; and to be long, with full strong riffs and high-pitched vocals which may well serve to make the lyrics audible over 'road-hum' in certain cars. But, is this enough to amount to some sort of recipe?

Anyway, most of our respondents, including one who worked in a major music store, felt that the 'driving song' was dead as a concept for all except a few older men.

Salisbury says that although producers may give a certain consideration to how pop music may sound in a car – it is part of the overall sense of what constitutes 'radio-friendliness' – in contemporary terms, the notion of the 'driving song' has become outdated. "More people probably listen to house and garage than rock in cars anyway," he says. "But the point is that people always want to match music to their mood, and now so many have mp3 players, it has become much easier to do that."

In general, interviewees were indeed far keener to talk about matching of music to mood than about 'classic' driving songs. To some, music only seems to 'make sense' on the road:

"All music sounds better in the car. I didn't understand West Coast hip-hop until I drove around LA, where everyone goes slowly, listening to it. You appreciate things when you're doing something else."

Female driver, 40, London

02





"I listen to a lot of audiobooks and I like to match them to the places I'm driving through. I remember one summer I was driving up and down the A1 a lot at night, and I used to listen to Dodie Smith's *I Capture The Castle*, which is set in the English countryside. I used to wind down the windows and let the warm night air smelling of cut corn and grass come into the car – it was a unique way to experience a book."

Male driver, 41, London

Recognising this desire for personal music choice BMW models are beginning to incorporate an in-built mp3 player and USB port, as well as mp3 connections.

Again, what underlies this approach to music and sound in cars is the modern sense of the emotional impact of an experience. It has something in common with the thinking of Seth Horowitz<sup>4</sup>, originator of the 'Neuropop' project which identifies the emotions carried to the brain by specific auditory nerves, works the sound frequencies that stimulates those nerves, and then makes music based on the effect required.

#### 4.8

##### Singing in Cars

Whether we care to admit it or not, singing is one of the greatest driving joys. The enclosed environment of the car seems actively to encourage singing. Drivers sing alone in cars, seemingly unaware that anyone can see them, and they enjoy family sings-songs on long journeys

– cars are one of the few spaces where the old tradition of singing communally and informally survive. Research indicates that singing may encourage better driving and safety on roads. Dr Nicola Dibben<sup>5</sup>, a music psychologist from the University of Sheffield, concluded that music aids safe motoring and enables drivers to relax, concentrate and keep themselves alert while on the road.

Observing singing habits during our roadside observations, we saw that, perhaps predictably, the weather seemed the greatest determinant in whether people sang or not; in overcast or rainy weather we spent entire days when we saw no one singing in their car at all, but in bright sunshine, on the same roads, the numbers would increase up to approximately one in five drivers. Women and men sang in roughly equal proportions. The most surprising tendency involved what we assume were work-related journeys. People sang in far greater numbers – up to four times as many – in the morning rush hour than the evening one, that suggested that we sing on our way to work rather than from it. And people who drive vehicles suggesting they were engaged in work as they drove tended to sing more than those who appeared to be on more leisure-based journeys.

#### 4.9

##### Getting out

We have talked about the driver assembling him/herself in and with the car. There is also a fascinating process of 'disassembly'<sup>6</sup>. The intimacy of the bond

01

Car-aoke: singing in the car was identified as one of life's great pleasures

02

Getting lippy: separation from the cocoon of the car calls for lipstick

01



between car and driver is such that disengaging is often – however routine – attached to a re-alignment. The walking body is after all different to the driving body, the passenger-driver relation is different to the wife-husband relation or the relationship between mates. The in-car social and bodily systems must be re-aligned in preparation for the next engagement – with leisure space, with shopping and with work. We must make ourselves (up) again. In the case of some females observed, this was quite literal. They couldn't leave the car without checking make-up. This 'check' is often not a real check, it is a cursory glance.

Just as BMW pays attention to the drive experience, it has also worked to enhance the ritualised experience of leaving a car. Follow Me Home, for example is a programmable iDrive feature that turns lowbeam headlights on for a selected time when you leave the car, allowing time, say, to reach the garage or the front door, or the garden gate. Meanwhile BMW Comfort Access will ensure that your car won't lock if your key is inside it. And, of course, the last noise you could hear is the gentle one of BMW Automatic Soft Close doors. After all, the story of your driving experience doesn't end until the moment you leave your car entirely.

On that score, our research highlighted a variety of time and modes of disengagement. One driver was able to stop, park and leave the zone of the car in seven seconds. Four seconds to get out of the car and three to stride off. More than half of the respondents took a glance back, some giving quite long and lingering looks to their

beloved cars. Others simply dashed off – with a flick of the electronic locking key fob.

At the other extreme one family took a massive ten minutes. The children had to negotiate what they could or could not bring from the car, the infant had to be disassembled – ie, taken from car and baby seat – and then 're-assembled' in the push chair. The older children donned helmets while bikes were taken from the rack on the back of the car. There was a distinct order as mother and father dealt one by one, and in reverse age order with the three children; then bags were packed and repacked with provisions and toys for the day – and all in a spirit of negotiation and care – as the alertness applied to the road by the driver was passed to both parents watching the car park for cars lurking carelessly, and for children wandering accidentally into danger.

The transition from in-car assembly from road/car network to work, leisure or social network is complex and can be fraught. Its underpinnings are that all such transitions and re-alignments however subtle are emotional.

The average times (from 40 cars) were:

- i Males: 8 seconds
- ii Females: 10 seconds
- iii Couples: 12 seconds
- iv Families: 1 – 10 minutes

02



01



Both males and females looked back more than 60 per cent of the time – to, as it were, say ‘goodbye!’ and just to check that the car was ‘all right’ – perhaps clocking its location in the car park, but also just ‘making sure’.

#### 4.10

##### Here comes the bride

It is impossible to discuss cars and relationships for long without acknowledging weddings. Wedding celebrations are one of the last traditional social rituals left in the West, and with everyone playing parts and dressing up, it is no surprise that cars, a prime part of our lives and means for self-expression, play such a leading role. For most respondents, cleaning the car before a wedding was felt to be essential.

Of course cars themselves are part of the wedding ritual between bride and groom, and felt to be so:

“The car was such a big part of it for me. Stepping into a fantastic car – it was like the real beginning of the day. That’s when I felt scared.”

Female driver, 28, Edinburgh

Of course the wedding car holds great significance for the bride’s family as it reflects them and what they hold dear; it is a public display. The bride arrives protected in the car – marriage is still a property deal in this sense – the bride is precious cargo, wrapped not only in a dress but in a ribbon-tied car. In a sense this is another example of the car as an extension of domestic environment – in many ways it represents the bride’s parent’s house.

Of course, the car the couple leaves in will either be stripped down (as opposed to embellished) – quirky or rickety. The silly string, tin cans etc make the car real, funny and ridiculous. The cans are added as a sign of the divestment of grandeur of the car the bride arrived in – it’s a way of saying the car is naked and vulnerable. This ritual may in fact be a continuation of an ancient one whereby revellers would position themselves outside the bride and groom’s room at night calling in good humoured mockery at them.

But it is not only the happy couple for whom cars are important. For guests, the cars they have arrived in often provide a little escape.

“I remember the last wedding we went to, it was quite posh... and we were frazzled by the time we arrived at the reception, so we sat outside and waited in the car for about half an hour before we went in. I was grateful that we could do that.”

Male driver, 41, London

There is a sense of identity, status and membership all being in flux at weddings. After all, relationships are changing completely on that day, people are conscious of their identities, new friendships are being formed – or not – among the guests. Little wonder then that as well as being a public statement the car also provides a refuge and a cocoon during a public, all day event. People might get changed in it, children will be put to sleep in it, people might retreat to listen to the football results.

Cars also provide a way of helping at weddings – ferrying flowers from the church, or going out to fetch the bride’s favourite CD, and will as a result often feature in memories of the day.

“At my friend’s wedding, the family needed to get the floral displays from the church to the hotel where the reception was, and they realised after the service that they hadn’t organised how this would be done. I had the only car that would accommodate them, so I took them. I must admit I did feel sort of proud – well, not proud but pleased that me and the car could help.”

Male driver, 36, York

#### 4.11

##### Make it easy on yourself

Many of the situations described above involve moments of stress, and it is here that BMW can help. Of course, no car manufacturer would claim to be able to soothe an irritable child or resolve an argument between husband and wife; but in constantly seeking to improve the driver’s experience, BMW can reduce some of the anxiety arising in such situations.

“Driving is psychologically very demanding, and the demands increase in heavy traffic,” says Klaus Bengler, BMW Driver Interfaces Psychologist, citing some BMW features that help relieve the psychological burden. Active Cruise Control, for example, takes away the need for a driver to control distance from the car in front; Lane Departure Warning and Active Steering are also helpful. BMW also pioneered the use of a display screen at instrument level, and is now moving ahead again with the Head-up Display (see chapter 3.7).

As well as reducing potential for stress, such features empower the driver to focus on the experience of driving. Whatever the situation, for BMW the enjoyment of driving remains the priority.

---

01  
The wedding march: the right car is an integral and symbolic part of the western wedding rituals

---

## Chapter 5.0

### You and yours

"My car is subtle, but it says the right thing to the right people. It's quite sleek and discreet, but when you want it to, it goes like a rocket. My car could bemisinterpreted, but at the same time, those who know me know why I like that car. It's a personality extension."  
Male driver, 21, Hull

"If a man was picking me up on a first date and I looked outside and saw an ostentatious £200,000 sports car, I certainly would not fancy him. I would assume he had some serious psychological problems, and pretend to be out. I don't think most people see cars like that any more. But yes there could be interesting things about someone's car, but just being showy is... no thanks."  
Female driver, 36, York

"I think people in the UK are generally less impressed by big cars for their own sake nowadays. It's more a question of you and the car, what the car says about you in different ways. For example, I would hope that people think my car is looked after well, that it is clean and in good condition."  
Male driver, 28, East London

---

01  
Wearing the car: cars have always expressed their drivers' personalities - but their meaning is changing in subtle ways

---

## 5.1

### Cars and self expression

Ever since the car was invented in the late 19th-Century, drivers have, to varying extents, regarded their choice of cars as outward expressions of their own identity. "The automobile," Peter Marsh and Peter Collett write in *Driving Passion: The Psychology of the Car*<sup>1</sup>, "satisfies not our practical needs but the need to declare ourselves socially and individually." Of course, this means that as our sense of our own identity and the world around us changes, so does our sense of the car as self embodiment. This has rarely been truer than it is now, as the world moves into a new century and out of the old industrial age.

When considering this subject, it is worth bearing in mind a few facts. First, motoring has become much cheaper in the past three decades in relative terms (see figure 1, overleaf); the growth in car travel since 1980 has been accompanied by a reduction in motoring costs in real terms, while over the same period, average disposable income has almost doubled in real terms. Second, there is growing awareness of one's social impact as a motorist. The proportion of adults who understood that emissions from transport are a major factor contributing to climate change increased from around 40 per cent in 1996/97 to 65 per cent in 2001. And finally, the proportion of adults who claim to have used cars less for short journeys increased from 33 per cent in 1996/97 to 39 per cent in 2001. (Figures cited: Department of Transport 2006.<sup>2</sup>)

There is also a significant shift in general attitudes taking place. Like other German car brands, BMW has long been able to divide European car buyers into three basic groups: traditionalists, social climbers, and social progressives<sup>3</sup>. Over the past ten years the first two groups have been overtaken in terms of power and influence by the last one. This group is less concerned with conventional materialism, and more with what they can feel and experience.



01



Researchers have for some time noticed a gradual transformation in ideas on how products are used. In their book, *The Experience Economy*<sup>4</sup>, for example, Pine and Gilmore argued that businesses should offer products that create usage beyond pure functionalism, delivering experiences for their audiences. This sits comfortably with the shift towards social progressivism, although it is crucial to understand that this is not simply a rejection of one set of values for another, but the evolution of a new way of thinking about cars altogether.

"One thing we've noticed is that a lot of people coming in have more disposable income and they want to be sold to in a better way. The general form is that you don't throw 'bling' at something because people won't go for it. Instead you turn it round the other way, you know, you show design and style."  
 BMW dealer, Oxford

Talking to interviewees about their feelings and anxieties about driving, we found that these feelings could be separated into two groups. One was about position in relation to others ('status'), the other about everyday tasks – holding things together, and getting from A to B ('coping')<sup>5</sup>. While status referred to self-presentation and identification, coping referred to self management. 'Coping' is the internal self experience of enjoyment in mastery of body and space, a private satisfaction and a thrill at coping with – or fulfilling – the task. Its antithesis is 'falling apart'. 'Status' is the externally derived, performative aspect of pleasure in

being seen and admired. Its antithesis is being overlooked.

BMW design has ensured that the outward appearance of the car will attract admiration, but also recognises – and this is where the new set of values comes in – that the 'coping' dimension expresses a quieter and more private but no less widely felt driving pleasure.

For the new, 21st-Century driver, taking pleasure in the car's ability to deliver that 'coping' exhilaration turns the sense of status inwards, transforming it to a personal sense of pride, satisfaction and joy. One might draw a comparison with the iPod; the pleasure it delivers, the urge a new owner might feel to show it to another to share one's delight in it, is not derived from the volume of songs it can store but the perfect combination of looks and usability. The key is the emotional relationship with the car as a whole.

"My relationship with my car is friendly, quite affectionate – I refer to it by name. I look after her and care about her, from a wanting-it-to-look-nice point of view. I look out of the window at it every day – I worry that I might have blocked another car – but also, think, ah, it's my little car."  
 Female driver, 35, South East

---

01  
 Balance of payments: the potential for motoring spend has changed significantly<sup>2</sup>

---

02  
 Room with a view: one respondent expressed her pleasure at simply looking at her car

---

03  
 Brake dancing: usability now lies at the heart of great design

---

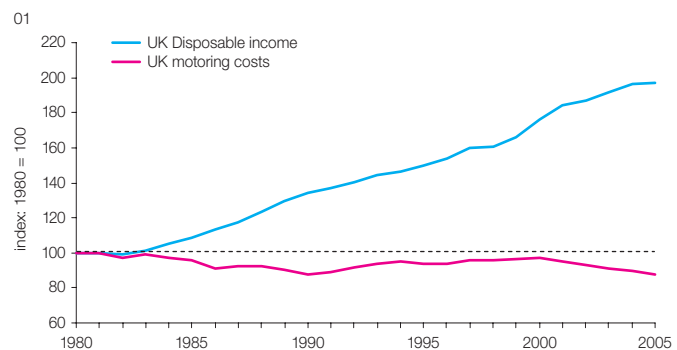



## 5.2 Brave new brand

For Chris Bangle, these changes represent a fundamental shift in the way brands, products and consumers interact. "We used to see the layers of product over user over brand. That is how vehicles used to be in the Sixties," he says. "We considered first the product, then who would use it, then how that would affect the brand."

"Today we have a new hierarchy: brand, user, then product on top. This has redefined the idea of the iconic vehicle – before that just meant you remembered it. Now it is different – iconocism now isn't just about remembering what the car looked like. It is about being the leader breaking the wave in which everyone else is trailing."

"That means you are the first to solve a problem, or some conflict that stopped this vehicle from existing. Think off-road, on-road driving and the X5, or of a small car that is premium – the MINI. When you solve that problem, you do it with a small group of believers that slowly grows."

For Bangle, an 'iconic' product is now one that is sufficiently powerful in its identity to redefine the brand from which it comes. The iPod redefined Apple, Louis Vuitton's Marc Jacobs/Murakami bags redefined the venerable European luggage brand, the X5 redefined BMW. This change belongs to a shift away from the reliance on branding towards the product itself, or the

"Return to the emotion of product over brand – a more authentic kind of emotion that people are more in touch with."

This shift, he believes, is also re-emphasising the role of the driver, consumer or buyer – and it is only the beginning. There will be another huge leap within the next 20 years. "Around 2020 we will have another paradigm shift. The need for emotionalism is a part of that. The ramp-up is happening already."

## 5.3 The new rules

The changes discussed above do not mean that drivers no longer wish to use their car to make statements about themselves, nor care about individual identity – in fact there are some fascinating emergent trends in this area.

For example, BMW dealers have recognised a move towards what one could call green-upmanship – a tendency to worry about whether their car looks 'un-green'.

"You have a woman, let's call her Mrs Smith, who drives her 4x4 to drop her kids off at school, then she goes to her dinner party and Mrs Brown says, 'Oh, I couldn't possibly drive my 4x4 any more. I've had to get rid of it because of this.' And then somebody else in her same parent group does it as well, her 4x4 is gone."  
BMW dealer, Oxford

02



03



"I don't think it's widespread at all, but there is definitely a clique of people who want to be seen to be green. It's not just the ecological thing – it's also a way of being modern."

Female non-driver, 36, London

Because genres of car are often seen to be associated with a lifestyle, (for example, the nippy hatchbacks for the young, people carriers for the family, and so on), some drivers who are reluctant to be stereotyped are concerned that cars can make too overt a statement:

"A car says more about you when you're young, I think. When you get older, it becomes an expression of the compromises you have to make. When I was pregnant, I started to have this idea that I needed to get rid of the convertible. But then I thought, why? Why do I need to get rid of it and have a different car? So in the end I didn't. But people have this idea that they have to move into this new world. Maybe you need four doors, but that's about it."

Female driver, 38, London

Consistent with the anti-statement feeling is British reserve, a powerful factor in how a car projects its personality. There is a discernible trend towards understatement and this attitude reaches its peak on the practice of debadging. A debadged BMW M5 looks much like any other 5 Series saloon. Only a cognoscenti will recognise it has a 507 bhp engine by the twin quad exhausts.

## 5.4 Whose hue

Even given the array of cars available to purchase, paradoxically it may be that asserting individuality is getting harder and is far more complex than the simple projection of a vehicle's value:

"A couple of days ago I saw a real rustbucket, and I thought – that's a statement of individuality. Even people driving round in a classic splitscreen camper van – even that's not making a statement anymore. Only a really old car or a very expensive car will make a statement of individuality."

Male driver, 36, London

Trendspotters in London have recently noticed a strange customising trend – analogous perhaps to buying new jeans and distressing them to achieve an aged look – using sandpaper to rub paint from a car, deliberately allowing surface rust to develop. However, we feel fairly confident in predicting this is unlikely to become commonplace. Far more significant is personalisation.

Of all the trends relating to projection, personalisation at the point of sale is perhaps the biggest. Where drivers were once offered a basic model with a range of paint colours and upholstery, 'spec' choices now reach deeper into the skin and muscles of the car. BMW's regular option programme allows a vast choice of leathers, colours, interior material, devices, systems and features – so many, in fact, that even at their largest

01  
What's your colour? The breakdown of popular BMW paint finishes reveals much about our tastes

01

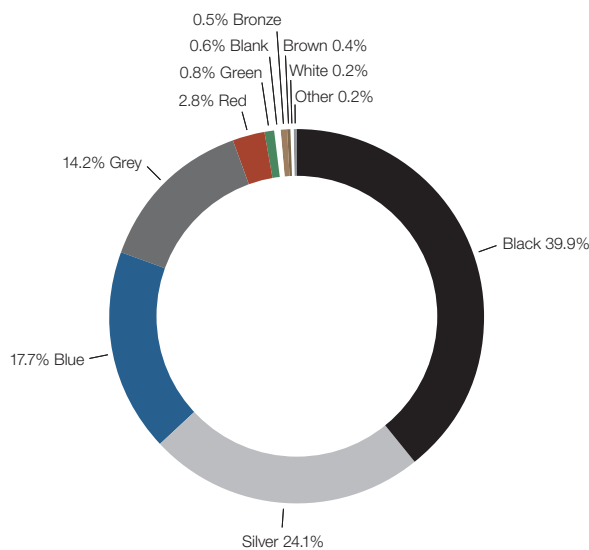

manufacturing plant it would be at least ten years before another identical car travelled down the production line. And that's not allowing for the infinite possibilities afforded by BMW's Individual Programme, where you could even opt for a car to match your favourite outfit.

The choices of BMW colours chosen under the regular option programme are dominated by black, grey and silver, although there are some curious and fascinating regional anomalies in percentage terms. For example, purchasers in the:

- i South West and Wales choose blue far less often than those in other regions, and buy more black and more silver than any other region (although London's figure for black cars is very close);
- ii Greater London are by far the most averse to green (the East Midlands is keenest);
- iii Scotland are the most likely to choose red, and the least likely to choose grey.

Perhaps the brightest request was for neon pink. And yes, it was sold – a 3 Series to a purchaser in the North West.

As for what this may say about the individual regions – well, that is better left to a professional colour analyst. As one such, Leslie Harrington of LH Color<sup>6</sup>, points out, the psychology of colour is complex, and can involve many different determinants – gender, for example.

"Based on our surveys, I'd say blue seems more emotionally active for men. It seems to stimulate

emotional response more quickly and with more intensity than it does for women. Women like more variation in the colours in their environment, and associate highly coloured environments with positive feelings. Men don't like a lot of colour variation. This is important if you're trying to create an environment for people where they will feel comfortable and stimulated; a workplace, maybe. Black is more emotionally positive for men than for women. But we need to be careful about the kinds of conclusions we draw for this sort of thing."

The future could see more variety in the colours on offer, and more adventurous choices being made. Some business commentators, including Chris Bangle, predict that we will adopt a 'wiki-economy' – that is, a decentralised set of markets in which people use technology to form informal networks for buying, selling, education and entertainment. Instead of shopping at supermarkets, for example, groups of consumers might gather into small collective groups to 'commission' food from small producers – in fact this is already effectively happening in some parts of the country. Similarly, like-minded individuals will be able to commission individually created cars from BMW, and work with others so that their choices need be less constricted than they are today.

Bangle explains: "Inability to resell is a big financial constraint keeping people away from self expression. But when our economy changes to a wiki-economy, you can put your car online and it will sell itself. Then buying a yellow car is no big deal; you will always find someone to

01



sell it to when you don't want it anymore. Right now we're seeing a huge wave of consumer empowerment," he points out. "The wiki-economy hands huge power to people. That means greater expressionism, and cars that really mean something to their owners."

## 5.5 Shiny happy people

Of course you can only see the colour properly when the car's clean, and for many people cleanliness was of equal, if not greater importance than the colour itself. For some, the act of washing the car was an important ritual that served as a sort of bonding experience. One respondent said he liked to wash his car after a long journey as a way of rewarding it for its hard work. Several, in fact, said they avoided a mechanical car wash because it felt "too brutal", and others commented that they took a certain sensual pleasure in sponging the car and watching the dirt wash away.

A few maintained the familiar Sunday morning ritual of washing the car, though in fact it was more common to tie the washing ritual in with another social one:

"I clean the car when I'm going to see my mum. The car isn't a friend, but it is something I enjoy using, definitely – not just a thing that gets me from A to B. It's much more than an accessory."

Male driver, 38, South London

"I clean it every July. I always do a picnic for friends and business friends in July; it gets a wash then."

Male driver, 38, East London

"As a farmer who uses the car for work, I end up with a very muddy piece of kit now and then. If I'm going to visit relatives in a city, I usually give it a good wash beforehand. I suppose I don't want to look like a yokel turning up. Mind you someone told me that city people like a bit of mud on their car because it makes them look as if they've got second homes in the countryside. Maybe I should open a muckwash on the M4!"

Male driver, 35, East Yorkshire

Common to most people's pleasure in washing their cars was a sense that, in the words of one interviewee, the process "revirginised" the car, returning it to its new condition. A new-seeming, pristine car emerged as one of modern life's great yet elusive pleasures, on a par with having the beach to yourself and the empty email inbox.

## 5.6 Designing tomorrow's cars

"I like the smell of new cars more than anything. Smell triggers more powerful emotions – old leather or new interiors. It makes me feel special when I get in a car."

Male driver, 32, South London

The trends discussed in this chapter speak of a changing relationship between driver and car, a striking sense of buyer empowerment, and a decline in deference to the buying process and showroom itself. Armed with

---

01  
Soap springs eternal: rituals of car care express a driver's emotional bond with their vehicles

---

extensive knowledge and choice, it is not inconceivable that in the future, car buyers will be able to select, personalise and order cars with the same ease, speed and confidence with which they place orders with online retailers such as Amazon.

Chris Bangle believes that we are already moving toward the “user-generated car” – a notion that comes to exist in a combination of possibilities offered by the manufacturer and preferences decided by the buyer. This idea is best understood in the parallel “user-generated” revolution of Web 2.0<sup>7</sup> where individuals determine their own experience, as against a previous era of web usage that centred on passive downloading and consumption of static, predetermined content. Embodied by blogs and “wiki”<sup>8</sup> websites that allow users to add, remove or edit content, the trend represents a socio-economic shift transcending the online world and beginning to alter the way we buy clothes and food, book holidays, listen to music and watch films.

Such a car, Bangle adds, has a new kind of character. “With cars there is implied give and take. It has a character, but it is the character of you using the car.” In the future, the car will be an embodiment of the driver, a machine in which the driver will determine exactly the experience of driving according to his or her own preferences.

Innovations such as BMW’s Key Memory herald this idea. As car production cycles speed up, BMW’s Chris

Bangle can imagine that within 20 years it will be possible to progress from initial design to finished car in ten days, rather than six years. Highly individual preferencing may almost enable manufacturers to tell a customer exactly what kind of car they want the moment they walk into a showroom.

“A car is an avatar,” Bangle says. “Already we have a situation where the seat changes, the radio changes, the heaters change, all to your preference when you put your key in the door. Can you imagine tomorrow, when the form of the interior will change, the colours, the smell? Then our job will be making sure that the configurations on that key really are you. That’s a huge challenge downstream. When that happens we are seriously into the next paradigm.”

---

01  
Through the keyhole: the BMW Key Memory remembers various drivers’ preferences

---

01

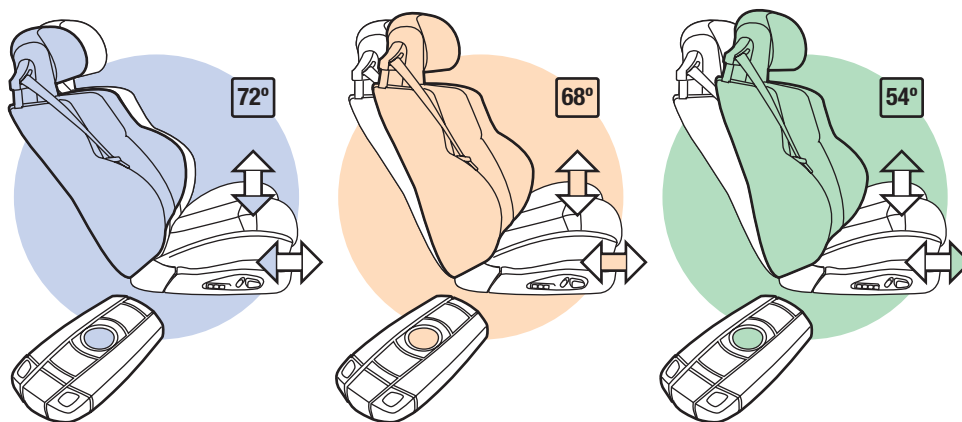





## Epilogue

"I don't feel like I'm ethically worried about cars and the environment. I don't drive mine gratuitously but I can't function without a car. I don't drive into town – I'll use public transport or cycle, but I'll pick up the kids and go to the supermarket."  
**Male driver, 38, London**

"We've noticed it a lot more over the last few months actually, you know, what are the CO<sub>2</sub> emissions, what tax bracket does it fall in?... OK, does that mean it has less brake horse power if it drops right down on CO<sub>2</sub>?"  
**BMW dealer, Oxford**

"I just came from LA yesterday...my hotel was looking over the 405 freeway...I have never seen so many cars in my life, 24 hours a day driving up and down one section of the freeway and you cannot compete with what is going on in the rest of the world. I hate to say it's futile because I don't mean it quite as blatantly as that, but..."  
**Male driver, 27, Oxford**

Let's be frank. It is clear by now that climate change is one of the most serious issues facing the world in these early years of the 21st-Century. It is widely believed that carbon emissions from conventional car engines contribute to climate change. As a car manufacturer, therefore, BMW is committed to minimising this environmental impact. Not only that; as a car manufacturer with a heritage of innovations that have solved problems and improved the driving experience, BMW expects itself to be a pioneer in this field.

"We don't see climate change as a threat but as a challenge," says Martin Ertl, BMW Innovations Manager, stressing that the company's vision is not simply to combat climate change, but to do so without reducing the enjoyment people take from driving. "We have to engineer a solution that is a BMW, and will be accepted as a BMW."

So what is BMW doing? Well, for many years now the company has consistently produced innovative technologies that address climate change. A key focus is the EfficientDynamics programme – an ongoing project committed to pushing forward efficient and thoughtfully effortless advancements such as: twin turbocharger technology that reduces fuel consumption and provides a smooth delivery of power; direct injection technology for optimum fuel efficiency; and reductions in engine weight. BMW has built cars that reduce fuel consumption and CO<sub>2</sub> emissions through the use of more efficient engines and lighter materials whilst still offering dynamic performance. It has introduced features such as Optimum Shift Indicator, which advises on the best gear for delivering fuel efficiency; Auto Start-Stop, which cuts the engine when stationary in traffic and Brake Energy Regeneration, which harnesses energy when the car is slowing down.

These innovations are available in BMW cars now. BMW is also looking to build cars with zero emissions and one answer lies in the BMW Hydrogen 7, the world's first hydrogen-powered saloon built on a standard production line, which when driven on hydrogen emits virtually nothing but water vapour.

BMW has spent 20 years researching hydrogen technology and is working to influence decision makers

and the energy industry to start the process of introducing the network that will supply hydrogen fuel in a usable form. Although commercially available now, the widespread use of the Hydrogen 7 depends on this infrastructure but as BMW's Martin Ertl suggests, it represents perhaps the biggest investment for the environment; "All electrical driving is, is a survival solution. We had to come up with a BMW that still is a BMW, which contributes to society on the one hand and on the other contributes to driving fun – and then that's fine – then we're in the game."

Innovations such as Hydrogen 7 have seen BMW recognised as a world leader in sustainable car manufacture. BMW Group is currently number one in the automotive sector of the Dow Jones Sustainability Indexes<sup>1</sup>. This index rates various aspects of performance in the economic, environmental, and social dimensions. An important factor in the company's favourable environmental performance is its powder-based clear paint technology, an eco-friendly process that doesn't use solvents or water.

In addition, BMW aims to use recycled material where possible in the manufacture of new cars. Some of the composite materials such as plastics that are recovered are taken back into the production process. This helps conserve scarce resources – it is estimated that 15 per cent (measured by weight) of the materials going into a BMW are recycled. For these, and many other reasons, BMW Group is the only company in the sector to have appeared in the Dow Jones Sustainability Index World and in the European Dow Jones Sustainability STOXX Indexes without a break since they were established in 1999<sup>1</sup>.

The engineers at BMW are keen to point out that all this has been done without reducing their trademark 'driving pleasure'. Because, as Ertl points out:

"We want to save the planet, but we want to do so with minimal expense to our lifestyles. There is nothing wrong with looking to the world's best engineers, designers and technologists to seek to combine the pleasure of acting positively to save the environment with the joy associated with driving the cars we love."

And as Ertl says, it is good for drivers to be demanding in this way, because it inspires BMW to produce better cars: "Sure, people want greener cars", he says, "but they also expect 'The Ultimate Driving Machine' and pure driving pleasure."

The truth is that most motorists are constantly being pulled in opposite directions – towards more responsible car ownership and, at the same time, towards the thrill of owning a muscular, gleaming, roaring piece of automotive fashion. In this way, there lurks a 'red devil' who enjoys driving regardless of its consequences. However, it is being kept in check by the increasingly dominant 'green angel', which ensures we are as likely to emphasise the vehicle's low CO<sub>2</sub> emissions as its top speed.

In truth, nothing has really changed in our relationship with the car in this respect. It may have become more furtive as our feelings have become repressed. But the red devil-green angel conflict within us is managed and expressed in what we drive and how we drive it.

"In general we're quite aware of climate change – we recycle at home. The car is a necessary evil – I don't see how we could function without one, unless someone produces an affordable alternative. I do use the car for short journeys – trips to the corner shops - and I could do more about that."

Female driver, 35, South London

In a study conducted in the 1960s, Dr Stephen Black<sup>2</sup> interviewed people about cars - firstly in ordinary awake conditions and then under hypnosis. In the normal condition he found that they were satisfied with the car design but were critical of the quality of workmanship and the price. They reported anxiety about danger and were in favour of seat belts. Under hypnosis, however, they spoke about the liberation and exhilaration of motoring, dismissing seat belts as timid and unnecessary.

These opposing images of the car are connected with the rational and the emotional. While the 'green angel' is concerned with safety and the environment, the 'red devil' is focused on automotive thrills and excitement. Discussion in our focus groups suggested these coexist. There was the need for token acknowledgement of green concerns to pacify the inner 'green angel':

"I hate to say it's futile because I don't mean it quite as blatantly as that, but ... I'll use public transport ... as long as we all start to make a bit of a gesture that we're doing something for the environment"

Male driver, 35 Oxford

Then, given the perceived pointlessness of having a green car when everybody else was giving in to their 'red devil' another respondent says:

"I think some of what he says is valid. I mean, yes, there is pollution and so on but if you look at the bigger picture of greener issues there's a lot more damaging things happening in the environment isn't there right, so aeroplanes for example, one flight from an aeroplane... so I'm also aware, if you look at the congestion on the road these days, something does need to be done... if people point their finger at me I can defend myself and say hey look, I'm not pointing my finger at you so don't point your finger at me..."

Male driver, 26, Oxford

Finally there was little need for further compromise, except for image purposes:

"People aren't so much worried about the environment as they are about what their neighbours might say."

Male driver, 48, Oxford

Overall, the Red Devils in us are balanced by moderate Green Angels and this is reflected very much in what we choose to drive.

From our research, it seemed that green issues meant that drivers feel a need to justify why they drive what they drive. These justifications reflect the type of person we aspire to be; we want to be seen as 'caring' as well as someone who appreciates good design,

01



02



engineering quality and power. This leads us to make car choices expressing these psychological aspects. Equally, what we drive influences our self-image. In a significant sense we become like our car; cars provide the potential for becoming who we aspire to be. One respondent's desire for a green car went beyond what was under the bonnet – he expressed the desire for an environmentally friendly interior:

"I'd get ethically sourced leather and sustainable wood for the dash if I could."  
Male driver 32, North London

But the car has to be consistent with other elements of our lives and to evolve to meet our changing lifestyles. New technologies must adapt to us, rather than us to them if they are to serve a purpose and survive. The contemporary car has evolved to fit in with the age in which we live. This is not technology being imposed on our lifestyles. It is technology that is responding to our changing lifestyles.

---

01  
Dream machine: BMW has a long term commitment to EfficientDynamics

---

02  
Driving down emissions: the Hydrogen 7 emits water vapour

---

## Methodology

### The research

The research was carried out between February and May 2007. The work gathers findings from a variety of sources including observational research, focus groups and driver interviews conducted in two phases; phase one was conducted by Peter Marsh (Social Issues Research Centre) and phase two, by Dr Iain MacRury (University of East London).

In addition, interviews were conducted by the editorial team with BMW personnel at the Projekthaus in Munich and with numerous external designers, architects and engineers.

#### Phase one

Social Issues Research Centre (SIRC): directed by Dr Peter Marsh.

The research was led by Dr Peter Marsh — co-director of The Social Issues Research Centre, founded in 1997 with Kate Fox, author of *Watching the English*<sup>1</sup>. Peter's main research interests have been in the field of non-verbal behaviour, leading to a number of books. *Gestures*<sup>2</sup>, written with Desmond Morris and others, won a Choice 'academic book of the year' award in the United States. Other publications include *Eye to Eye*<sup>3</sup> and *Tribes*<sup>4</sup>. A further, continuing research interest is in the role of the motorcar and driving behaviour.

Support team: Dr Peter Collett, co-author of *Driving Passion: The Psychology of the Car*<sup>5</sup> acted as a consultant to the project. Simon Bradley is the Research Director of SIRC. Patrick Alexander is a research associate at SIRC. Carole Love is a research associate at SIRC.

#### Methodology

The research was qualitative in its approach and covered the following key areas:

- Background desk-based research
- SIRC provided detailed research into the changing function and role of the car in 21st-Century Britain, taking into account all relevant social science developments in this area.

#### Qualitative research

The desk-based research provided the background for the main body of qualitative research undertaken in the project. This qualitative research combined interviews, observations and targeted focus groups to gather opinions and identify salient themes.

Focus groups were carried out to gather information about how the car is important to the identities of contemporary car owners, and to explore how they perceive their cars in relation to the wider social world.

The focus groups consisted of carefully selected car owners, and took place in SIRC's facilities in Oxford.

In addition 32 individual face-to-face interviews were conducted to explore specific themes that emerged from the focus groups.

SIRC also undertook a two day case study at a BMW dealership to explore dealers' perceptions of what their customers look for in a car, how this has changed over time and what it means to own a car today.

## Phase two

University of East London: directed by Dr Iain MacRury.

The research was led by Dr Iain MacRury, Principal Lecturer in Social Sciences, Media and Cultural Studies at the University of East London where he is co-director of the London East Research Institute. He has completed research and published numerous projects in the fields of consumption, culture and technology.

Support team: Professor Andrew Blake is Associate Head of School of Social Sciences Media and Cultural Studies at the University of East London. Emma Roberts is a Researcher at the London East Research Institute in the School of Social Sciences, Media and Cultural Studies at the University of East London.

## Methodology

The study used a range of specific methodologies to capture the key thoughts, feelings and analyses of the respondents.

Driver interviews provided the main bulk of responses and these came from focus groups, in-car observational one-to-ones and phone interviews.

The in-car interviews were of particular value in capturing drivers' feelings 'in the moment'. The immediacy of the driving experience – and the driver-car observed 'in situ' was designed into the research to allow researchers and respondents alike to apprehend driving experiences "live".

Driving is a physical and emotional activity and the immediacy of the in-car situation ensured that the team were able to observe interaction between car and person 'in their natural habitats'

In summary, the data set comprised of:

- Group sessions
- Ten individual in-depth interviews (various formats)
- Three days of in-car observational research
- One day of car park observation

Individuals and couples took part in the study and were asked to drive BMWs over a controlled period. The driving experience included:

- City roads
- Motorways
- Country/rural roads
- Car parks

Members (typically an interviewer/observer and photographer) from the observational team accompanied the drivers in the rear seat. The trip was audio-recorded with drivers asked to be as vocal and open as possible –





in response to specific prompts, but also providing spontaneous reflections and commentary - allowing the researchers to observe and log thoughts/emotions. At the same time the research team collected photos and notes. Once settled the drivers seemed largely undisturbed, so that for sustained periods conversation and observation occurred in a relatively "natural" way.

While researchers interacted with the driver there was no unusually distracting activity – ensuring the drivers' concentration was protected at all times. As well as the drive itself the drivers were invited to make use of sound systems and other features; to comment on the satellite navigation system and information systems for instance. Drivers were invited to select favourite musical tracks and introduced to different music as a background to the drives (for short periods) – inviting comment and observations on the in-car aural experiences.

The drives lasted between 45 minutes and one hour 15 minutes each, including an initial phase while the driver 'acclimatised' to the research situation.

The research drives were conducted in two locations; an urban/M25 group (directed by Dr MacRury) and a 'rural' group, around Eastleigh, Hampshire (directed by Professor Andrew Blake). The locations were selected to ensure that across the groups we were able to see drivers engage in as wide a variety of driving environments as possible.

The drives were designed to support observational/case studies/desk findings and to permit observation of, and reflections on the drivers, driving and the driving experience.





## Glossary

### Active Cruise Control

In addition to standard cruise functions, the system adjusts the car's speed according to traffic conditions and the speed of vehicles ahead. Using a radar sensor it maintains a safe distance from the car in front.

### Active Seats

The base of the seats undulate so as to have a positive effect on the lower spine and pelvic region, as well as preventing localised muscular tension. This helps to avoid tiredness over long journeys.

### Active Steering

Enables steering with increased accuracy and reduced effort. The amount of steering input needed varies based on car speed and driving conditions. At low speeds, only minimum steering wheel turn is needed when parking or taking sharp corners. At higher speeds it further improves stability.

### Adaptive headlights

Swivelling headlights illuminate a corner the second a driver steers into it. Responding to the changing steering angle and car speed, the system improves illumination of the road surface at night without blinding oncoming drivers.

### Automatic Soft Close

Uses electric motors to softly and securely close doors and the bootlid. Avoids slamming or driving off without the boot being properly closed.

### Automatic Tailgate

Using iDrive the driver can select a preferred maximum opening height for the tailgate, useful for regular users of low-ceilinged car parks.

### Auto Start-Stop

Automatically switches off the engine when the car is at a standstill and the clutch is disengaged, for example, at traffic lights. The car instantly starts up as soon as the clutch is operated. This function reduces both fuel consumption and emissions.

### Bluetooth connectivity

Drivers can use the car's telephone functionality and multifunction steering wheel buttons for hands-free telephone calls.

### BMW Assist

A telematics system using satellite positioning and communications technology to enhance safety and mobility. An emergency SOS function can be operated manually, or will automatically connect the driver to the emergency services in the event of airbag deployment. In addition, a driver can select to be connected to a BMW operator who can transmit to the car, contact details and navigation data for points of interest or businesses in the locality.

### BMW Central Building

Designed by renowned Pritzker Prize-winning architect Zaha Hadid, the BMW Central Building is the hub of the BMW factory in Leipzig.

### BMW Hydrogen 7

The world's first hydrogen production car is powered by a conventional combustion engine capable of running

on either petrol or hydrogen. When running on hydrogen it emits virtually nothing but water vapour yet still reaches 0-62 in 9.5 seconds.

#### BMW Individual Programme

A more extensive personalisation service from more distinctive colours, trims and accessories right through to unique customised approaches.

#### BMW kidney grille

One of the hallmarks of BMW design and also key to reducing aerodynamic drag.

#### BMW Online

Offers the driver an online web portal for access to information such as news and weather.

#### Brake Energy Regeneration

When the engine is in over-run, for example, coasting downhill, normally wasted energy is saved and used to recharge the battery. As a result the energy drawn from the engine is reduced.

#### Brake Force Display

Provides brighter illumination of the brake lights under hard braking, giving an important extra warning to following motorists.

#### Comfort Access

Allows the driver to open and start the vehicle or lock it without handling the key. Radio communication between the car and key checks identification and also prevents the key being accidentally locked inside the car.

#### ConnectedDrive

A strategy of seamless connectivity ensuring all information, communication and assistance systems work in harmony to offer safety, comfort and infotainment.

#### CAVEs:

To aid the car development process, BMW uses virtual reality CAVEs - electronic 'dungeons' at BMW's Research and Innovation Centre (FIZ) in the north of Munich.

#### EfficientDynamics

The umbrella term for BMW's extensive programme of measures to deliver a balance of enhanced performance with increased responsibility, from weight reduction, fuel injection developments, cutting the engine when stationary, utilising wasted energy from coasting and indicating the best gear to select, through to BMW Clean Energy which utilises hydrogen power. They deliver improved conventional driving character whilst still achieving significant fuel and emission savings.

#### Follow Me Home function

The driver can switch the headlights to remain on for up to 40 seconds after having locked the car.

#### Optimum Shift Indicator

Advises which gear to select for optimum fuel efficiency.

#### Head-up Display

Allows drivers to keep their eyes on the road, whilst vital information is projected into their line of vision via the windscreen. Speed, navigation directions and driver assistance information, such as Active Cruise Control, can be seen regardless of outside light levels.

#### High Precision Direct Injection

Fuel vapour is sprayed directly and in precise measures into the combustion chamber for more efficient use of fuel and maximum power.

#### iDrive

Through a mouse-like controller, drivers can electronically control more sophisticated vehicle functionality in an intuitive, interactive manner. Detailed climate, entertainment, communication and satellite navigation functions can be operated in a less distracting way.

#### Key Memory

Up to four drivers can save their own preferences on individual keys for seat position, air conditioning and radio.

#### Lane Departure Warning system

A camera fitted to the rear view mirror advises the driver when the car leaves its road lane without indicating, through the gentle vibration of the steering wheel. Should the driver have lost concentration or fallen asleep, they are alerted in a way that is less likely to cause over-reaction or alarm passengers.

#### Rain Sensor

The windscreen wipers are automatically switched on to an appropriate frequency to suit changing weather conditions.

#### Twin turbocharger

Two turbochargers divide support for the engine's cylinders between them providing increased performance.

#### Variable twin turbocharger

A small and large turbocharger work in sequence to provide seamless power throughout the rev range eliminating turbo-lag.

#### Voice Control

The driver can give voice instructions to control an increasing range of phone, comfort, entertainment and navigation functions.

## Appendix

### Introduction

Page 2

1. *Emotional Design: Why We Love (or Hate) Everyday Things*, by Donald A. Norman (Basic Books, 2003).

### Chapter One

Page 6

1. *Disciplines of Delight: The Psychoanalysis of Popular Culture*, by Barry Richards (Free Association Books, 1995).

Page 7

2. 'How different groups feel personally about their cars', (The Associated Press, 15 January 2007).

3. SIGMA is a market research company that explores consumer behaviour, through the use of its SIGMA Milieus (such as social climbers and social progressives), which deliver up to date knowledge concerning the linking of lifestyle, values, identity and everyday life aesthetics with consumer behaviour in the market.

Page 9

4. *Chaotic Cognition: Principles and Applications*, by Jonathan Bettle and Ronald A. Finke (Lawrence Erlbaum Associates, 1996).

5. The Cambridge Strategy Centre is a business and brand consultancy that provides brand development and strategy for companies such as ASDA, Heineken and Coca Cola.

6. Professor Gunter Henn is a German architect who designed BMW's Projekthaus and the BMW Research & Innovation Centre (FIZ) in Munich.

Page 10

7. The Massachusetts Institute of Technology (MIT) is a private co-educational research university with a strong focus on science and technology.

8. 'The world's most innovative companies: Their creativity goes beyond products to rewiring themselves', (BusinessWeek, 24 April 2006).

9. Herzog and de Meuron is a Swiss architecture firm based in Basel, Switzerland. The founders, Jacques Herzog and Pierre de Meuron are perhaps best known for the Tate Modern for which they were awarded the Pritzker Prize in 2001. The pair were awarded the Stirling Prize for Architecture in 2003 for the Laban Centre in London.

10. IDEO is a design agency involved in the re-design of public spaces to promote feelings of wellbeing,

productivity and creativity.

Page 13

11. Zaha Hadid is an award-winning Iraqi-British deconstructivist architect who designed the BMW Central Building in Leipzig, Germany.

12. Eddie Sotto is a former Disney imagineer who now, via his design company Sotto Studios, is involved in designing spaces and environments to make people feel great. Clients include companies such as Microsoft and Nokia.

#### Chapter Two

Page 19

1. Heston Blumenthal is a British chef and owner of The Fat Duck in Bray; regularly voted one of the finest restaurants in the world. He shared his memories of childhood picnics in an interview with Richard Benson in September 2006.

2. Discussion of the trouser factor appears in 'The Joy of Snax', *The Face*, September 1997.

3. *Small Things Considered: Why There Is No Perfect Design*, by Henry Petroski (Knopf, 2003).

4. Dr G. Clotaire Rapaille is a French cultural anthropologist and is internationally known as an Archetype Discoveries and Creativity expert. He was quoted by Malcolm Gladwell in the *New Yorker*: 'Big and Bad', *The New Yorker*, 12 January 2004.

Page 22

5. LH Color is a leading US colour consultancy that conducts research into the science of our emotional and psychological response to colour. They have found, for instance, that people are more creative in grey rooms and food tastes sweeter when eaten from a pink plate.

Page 22

6. Taken from Orange's 2005 'Blackout' advertising campaign.

Page 23

7. The RAC Survey, 'Commuting The Facts', was conducted in July 2003 by the RAC Foundation. The research was based on information from the census, the Labour Force Survey, and the National Travel Survey as well as information from the annual RAC Report on Motoring and the previous Lex Reports on Motoring.

Page 24

8. Herzog and de Meuron is a Swiss architecture firm

based in Basel, Switzerland. The founders, Jacques Herzog and Pierre de Meuron are perhaps best known for the Tate Modern for which they were awarded the Pritzker Prize in 2001. The pair were awarded the Stirling Prize for Architecture in 2003 for the Laban Centre in London.

Page 27

9. Gerhard Hofsetter, BMW Engine Sounds Designer, interview appeared in *BMW Magazine*, Spring 2007.

#### Chapter Three

Page 28

1. *Notes From A Small Island*, by Bill Bryson, (Black Swan, 1995).

2. *Automotive Nightmare*, by Alistair Aird, (Hutchinson, 1972).

Page 30

3. From an interview with a spokesperson from the RAC Foundation, May 2007.

Page 32

4. The double indicator flash would seem to be confirmed by the AA, whose spokesman reported that a double flash on the indicators to indicate slowing down came from lorry drivers, as they had longer braking distances.

Page 37

5. Japanese design company SGI Japan Ltd have created RoomRender, a futuristic room that responds to the emotions of those within it; adjusting colour and lighting based on the rhythm and intonation of voices.

6. Caleb Chung is a Japanese designer who has made a prototype chair which is able to respond to the emotional state of those who approach it.

7. D-Tower is an interactive sculpture in the Netherlands, conceived by artist Q.S. Serafijn and architect Lars Spuybroek/NOX-Architekten. Situated in the centre of the town of Doetinchem, D-Tower glows in response to the mood of the townspeople. Every day, thousands of inhabitants fill out an online mood questionnaire, and the results are displayed via the sculpture.

Page 40

8. Dr Frank Althoff, Interior and Driver Environment HMI Concepts.



## Chapter Four

Page 44

1. Philips ActiViva lamps emit a special light that promotes feelings of alertness and wellbeing. The lights positively affects the third receptor in the human eye, which is sensitive to blue light and influences our sleep/wake cycles and hormone secretions.

Page 51

2. Survey of 4,500 drivers conducted by Autoglass in February 2005.

3. Jamie Salisbury is a composer who has written award-winning scores for films, adverts, musicals and theatrical productions.

Page 52

4. Seth Horowitz, is a scientist who uses MRI scans to discover our emotional response to certain sounds. As part of his research he teamed up with a musician to write music that prompts feelings of joy and alertness.

5. Dr Nicola Dibben, is a music psychologist and Senior Lecturer in Musicology for the Department of Music at Sheffield University. She is a specialist in popular music, music perception, cognition and emotion.

6. The 'driver-car' relationship is developed by Tim Dant where he discusses 'assembly'. We have extended this to consider the 'disassembly' as drivers move from the car-driver link and to engagements with other networks, such as phones, pedestrians, retail and other forms or networks of transportation. See 'The Driver Car', by Tim Dant in *Automobilities* (SAGE Publications Ltd, 2005).

## Chapter Five

Page 56

1. *Driving Passion: The Psychology of the Car*, by Peter Marsh and Peter Collett (Jonathan Cape, 1986).

2. Figures taken from the Department for Transport, Transport Trends 2006 report.

3. SIGMA is a market research company that explores consumer behaviour, through the use of its SIGMA Millieus (such as social climbers and social progressives), which deliver up to date knowledge concerning the linking of lifestyle, values, identity and everyday life aesthetics with consumer behaviour in the market.

Page 58

4. *The Experience Economy*, B. Joseph Pine and James H. Gilmore (Harvard Business School Press, 1999).

5. For an extended discussion of status and coping in relation to communications and experiences of consuming cars and financial products, see *The Dynamics of Advertising*, by Barry Richards, Iain MacRury and Jackie Botterill (Harwood Academic Press, 2000).

Page 61

6. LH Color is a leading US color consultancy that conducts research into the science of our emotional and psychological response to color. They have found, for instance, that people are more creative in grey rooms and food tastes sweeter when eaten from a pink plate.

Page 64

7. Web 2.0, a phrase coined by O'Reilly Media in 2003 and popularized by the first Web 2.0 conference in 2004, refers to a perceived second generation of web-based communities and hosting services-such as social networking sites, wikis, and folksonomies - which facilitate collaboration and sharing between users.

8. Wiki economy, as written about by Don Tapscott and Anthony D. Williams in *Wikinomics: How Mass Collaboration Changes Everything* (Portfolio Hardcover, 2006) is a phrase referring to companies who open their products and platforms to enable collaboration and creation of next generation products and businesses. The word 'wiki' means 'quick' in Hawaiian but used in this modern, international context refers to the quickly changing world of Internet togetherness, also known as mass or global collaboration. Wikipedia, the online encyclopedia, written, compiled, edited and re-edited by 'ordinary' people is the most ubiquitous example, although there are lesser-known success stories that star Procter and Gamble, BMW, Lego and a host of software and niche companies.

## Epilogue

Page 67

1. Dow Jones Sustainability Indexes were launched in 1999 and are the first global indexes tracking the financial performance of the leading sustainability-driven companies worldwide. Based on the cooperation of Dow Jones Indexes, STOXX Limited and SAM, they provide asset managers with reliable and objective benchmarks to manage sustainability portfolios.

Page 68

2. *Man and Motor Cars*, by Dr Stephen Black (Secker & Warburg, 1966).

## Methodology

Page 70

1. *Watching The English: The Hidden Rules of English Behaviour*, by Kate Fox (Hodder & Stoughton, 2005).
2. *Gestures: Their Origins and Distribution*, by Desmond Morris (Triad Books, 1981).
3. *Eye to Eye*, by Peter Marsh and Robin Gilmour (Sidgwick & Jackson Ltd, 1988).
4. *Tribes*, by Desmond Morris and Peter Marsh (Pyramid Books, 1988).
5. *Driving Passion: The Psychology of the Car*, by Peter Marsh and Peter Collett (Jonathan Cape, 1986).

Notes

Notes

Notes

Notes



Notes

Notes

Notes