

rear RH side of engine compartment in E-Box

A7000

AGS transmission control module

X70001

Component connector (9-pin, Blue), AGS transmission control module

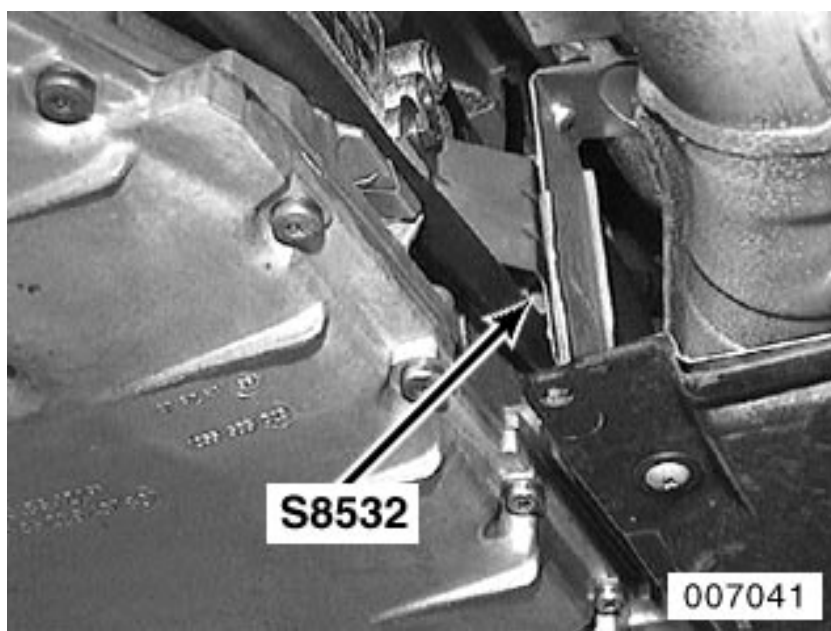

on RH side of transmission

S8532

Automatic transmission range switch

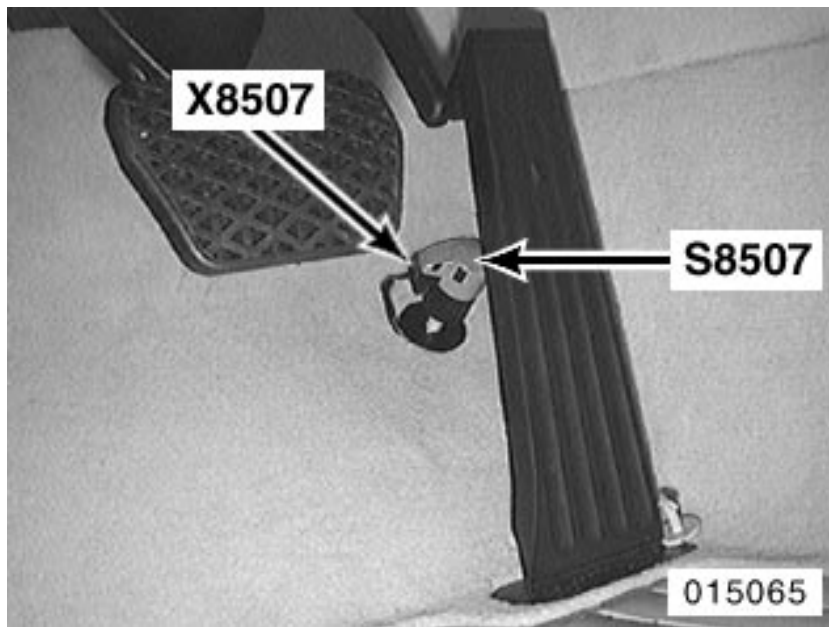

driver's side footwell

S8507

Kick-down switch

X8507

Component connector (1-pin, Black), Kick-down switch

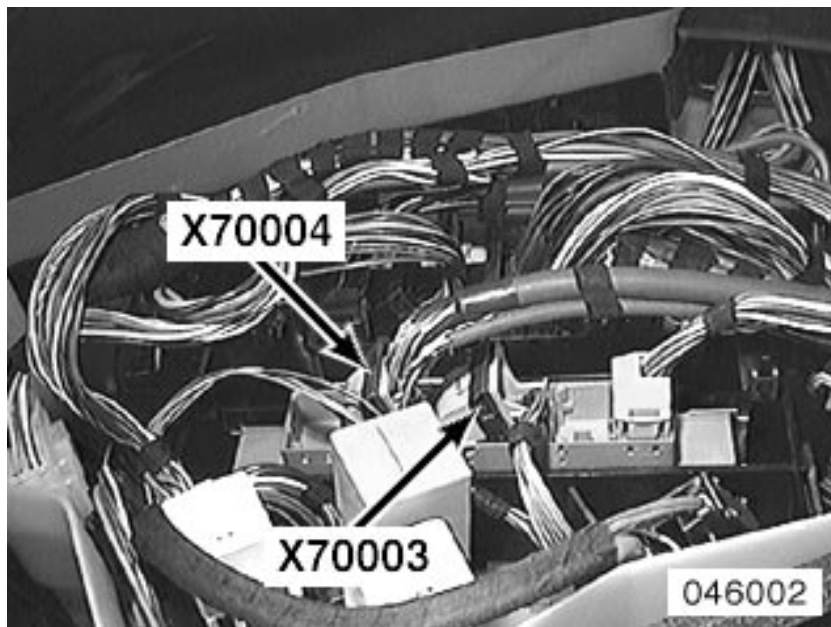

rear RH side of engine compartment in E-Box

X70003	Component connector (52-pin, Blue), AGS transmission control module
X70004	Component connector (40-pin, Blue), AGS transmission control module

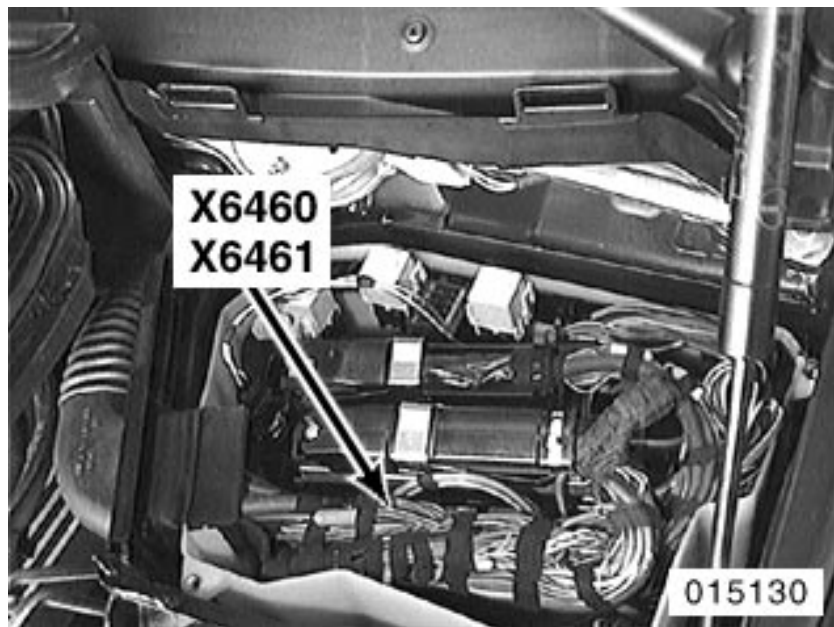

rear LH side of engine compartment in E-Box

X6460

Splice Terminal 31

X6461

Splice Terminal 31

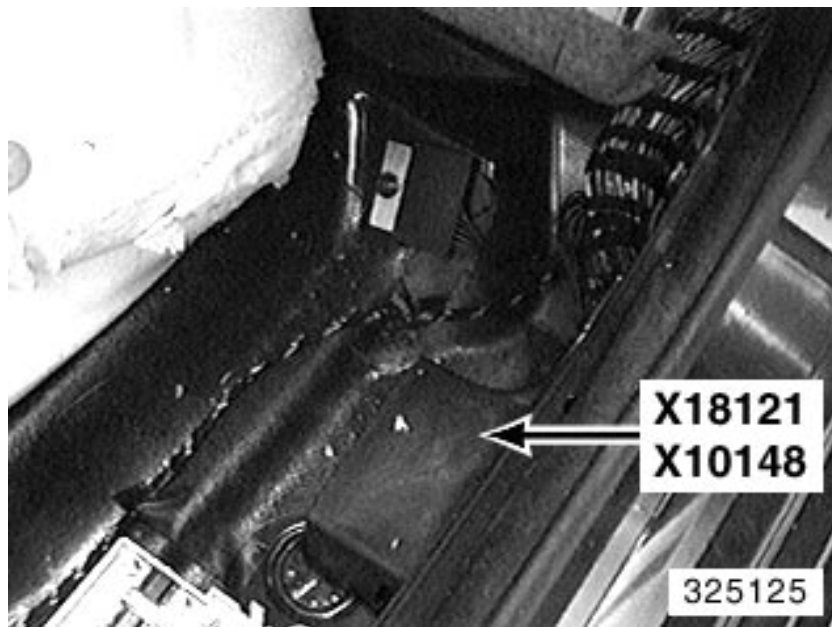

RH side of RH footwell under carpet

X18121

Splice Consumer cut-off signal

X10148

Splice I-bus

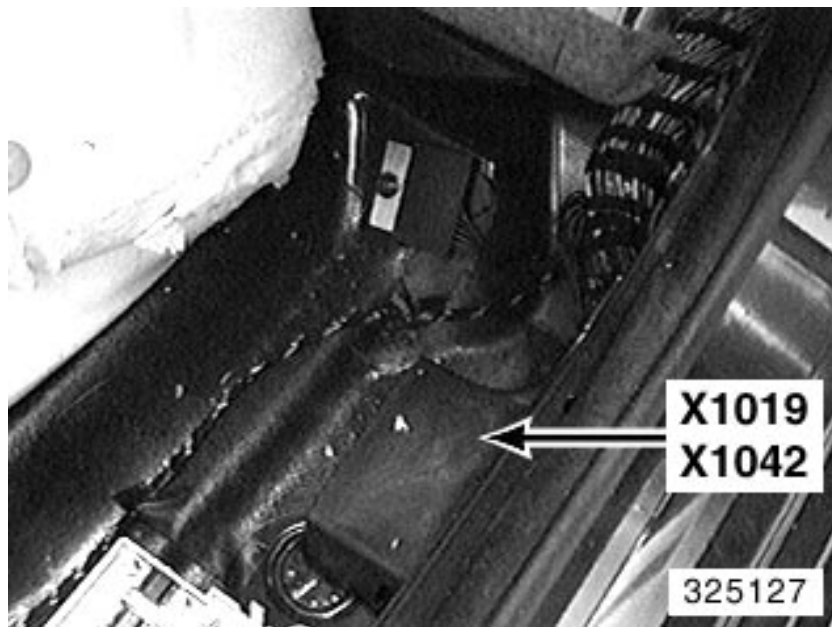

RH side of RH footwell under carpet

X1019	Splice Nighttime illumination
X1042	Splice Auxiliary heating

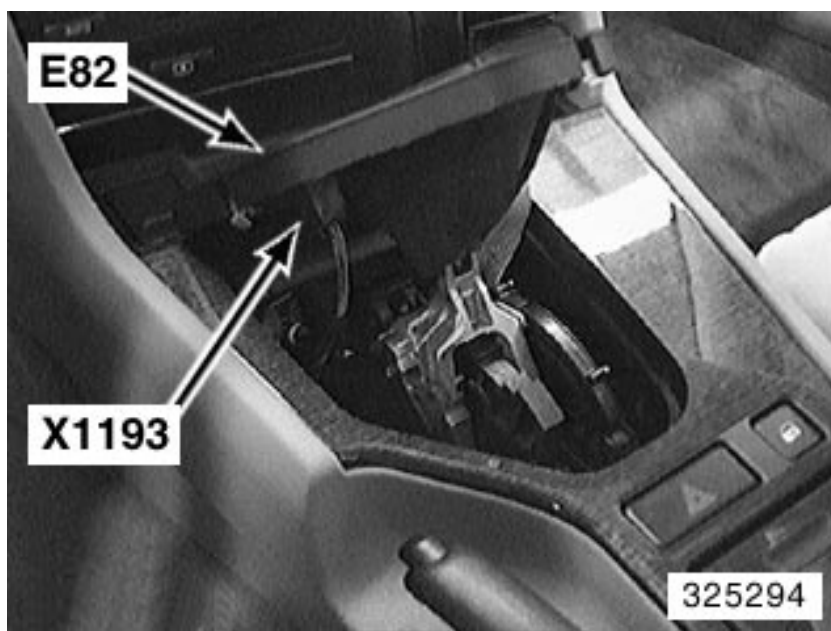

center console front

E82

Transmission range indicator light

X1193

Component connector (6 -pin, Black), Transmission range indicator light

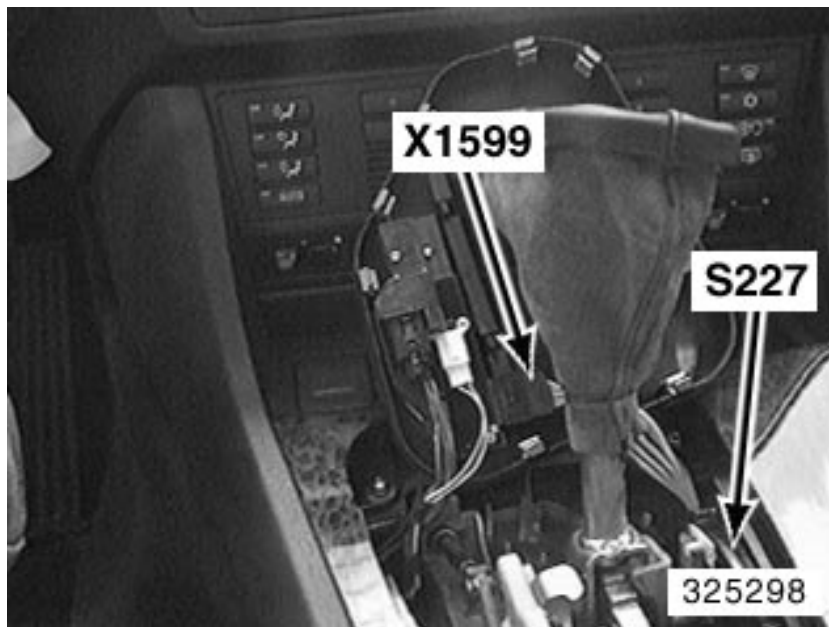

center console

S227

Selector lever position switch

X1599

In-line connector (6 -pin, Black), Selector lever position switch

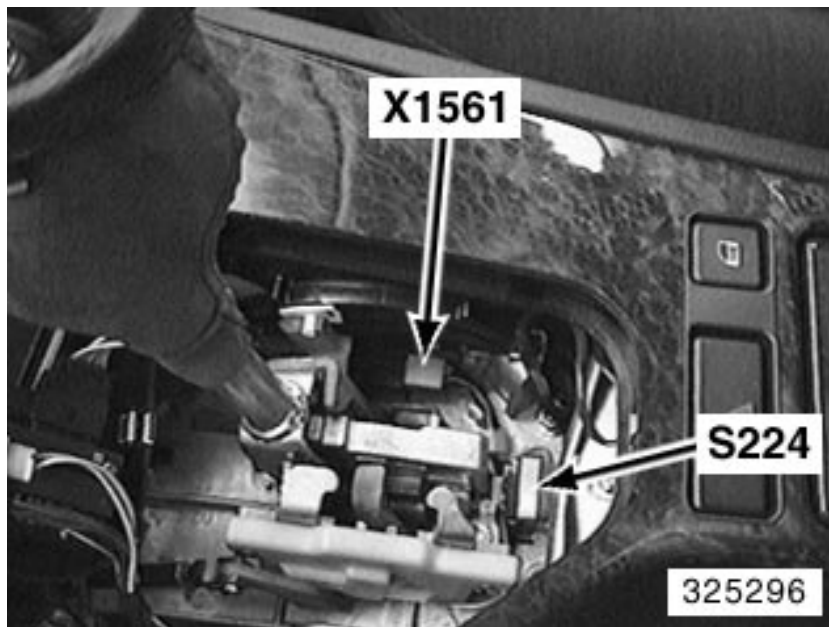

center console

S224

Steptronic switch

X1561

In-line connector (4 -pin, Yellow), Steptronic switch

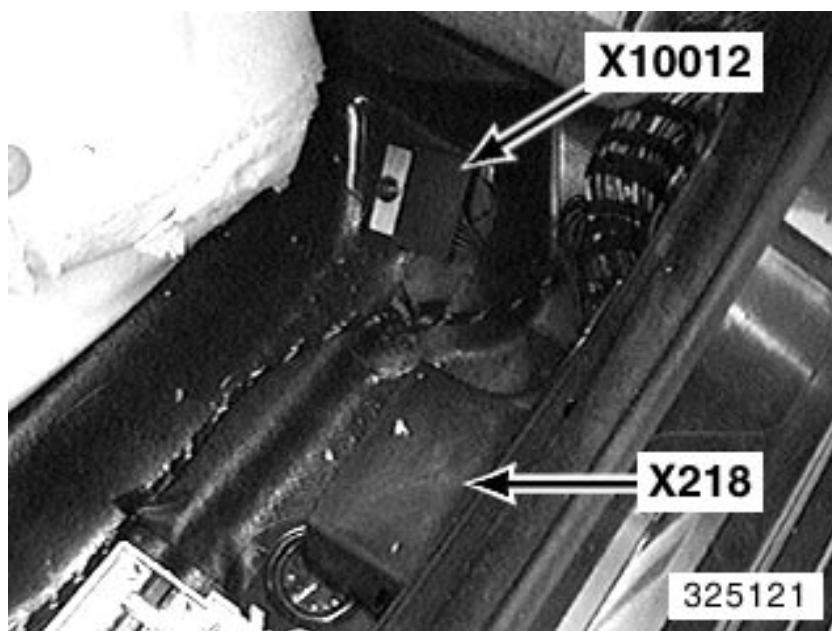

RH side of RH footwell under carpet

X10012

Cable shoe Ground

X218

Splice Ground

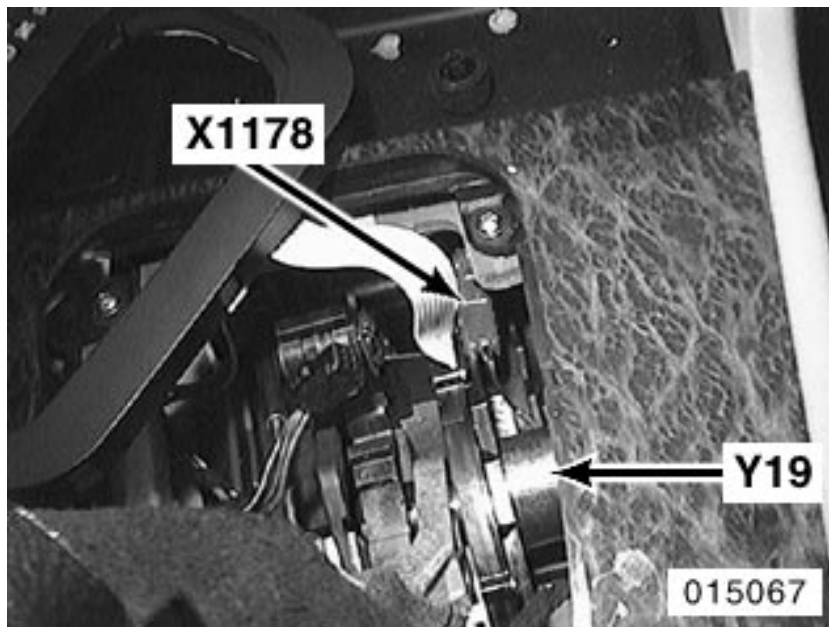

center console

Y19

Park/neutral position switch

X1178

In-line connector (3-pin, Black), Park/neutral position switch

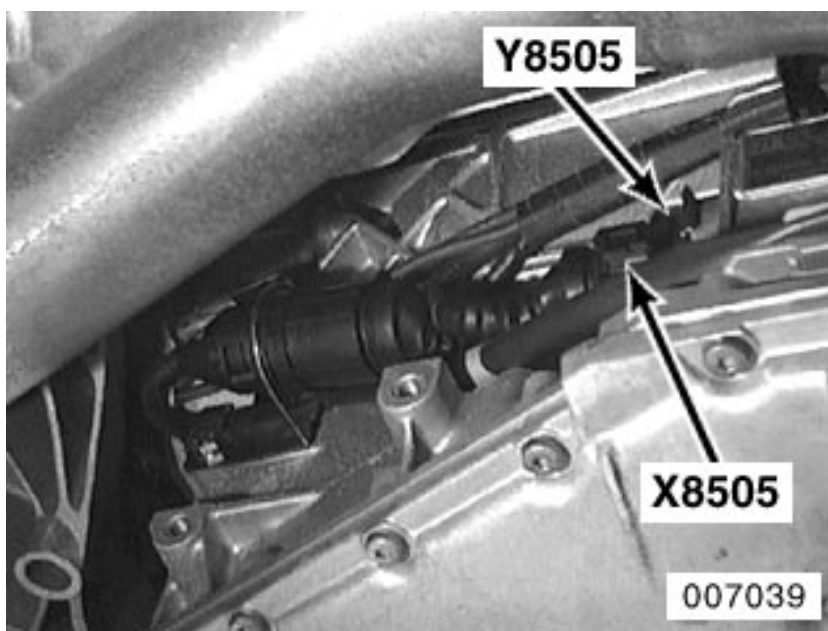

on LH side of transmission

Y8505

Transmission valve unit

X8505

Component connector (16 -pin, Black), Transmission valve unit

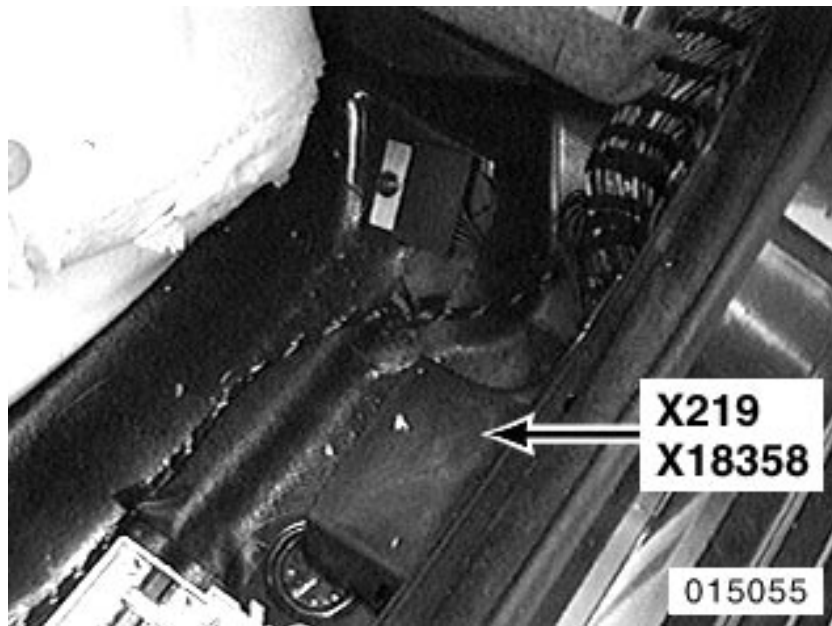

RH side of RH footwell under carpet

X219

Splice Ground

X18358

Splice Air bag ground

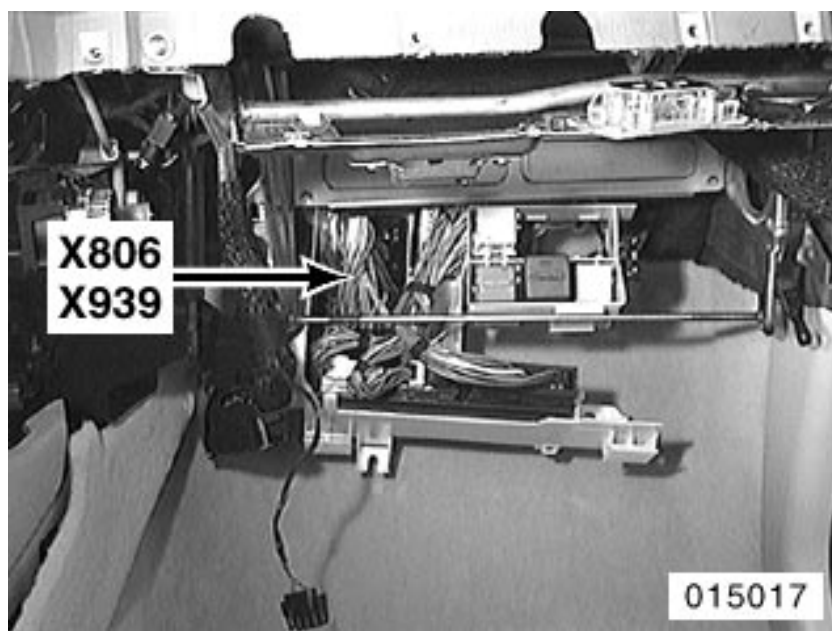

behind glove box

X806

Splice Light signal

X939

Splice Connector, I/K-bus

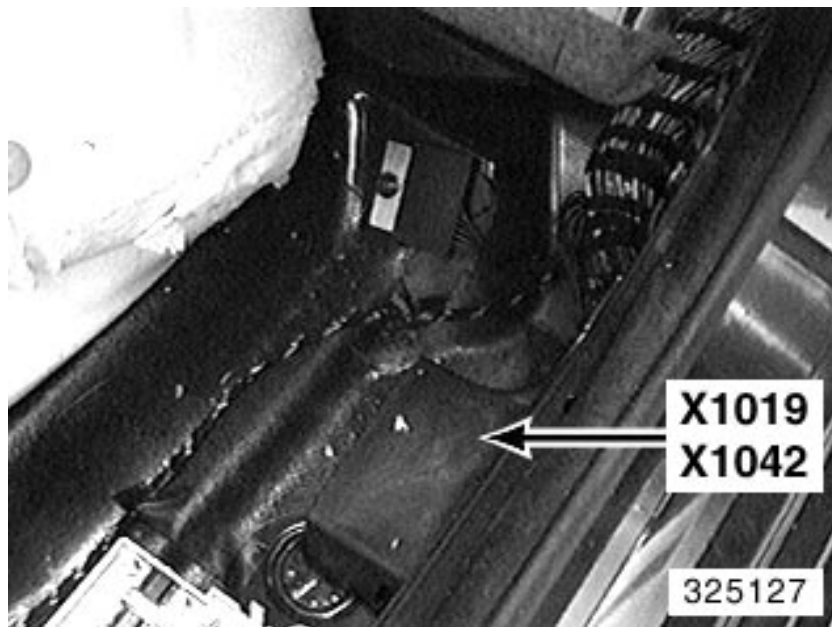

RH side of RH footwell under carpet

X1019	Splice Nighttime illumination
X1042	Splice Auxiliary heating

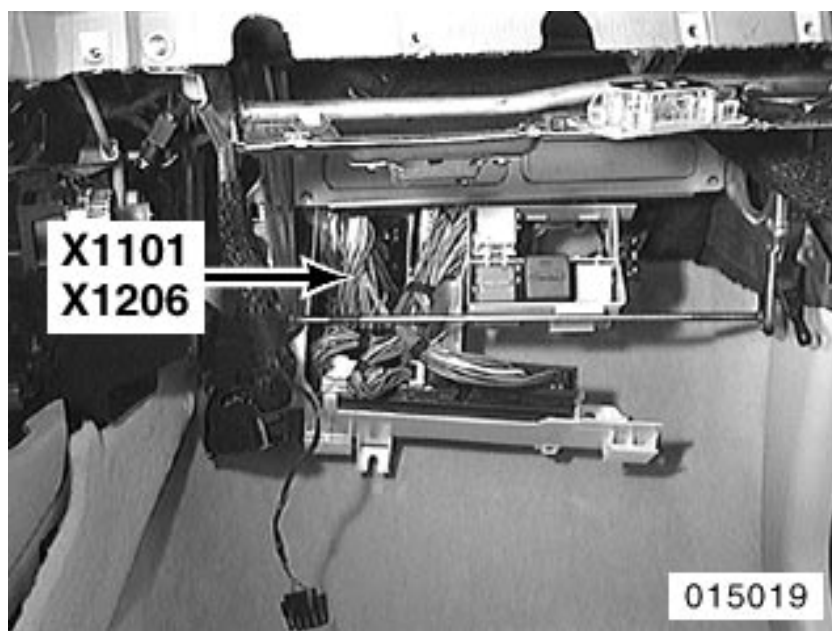

behind glove box

X1101	Splice Engine speed sensor signal
X1206	Splice Inclination sensor

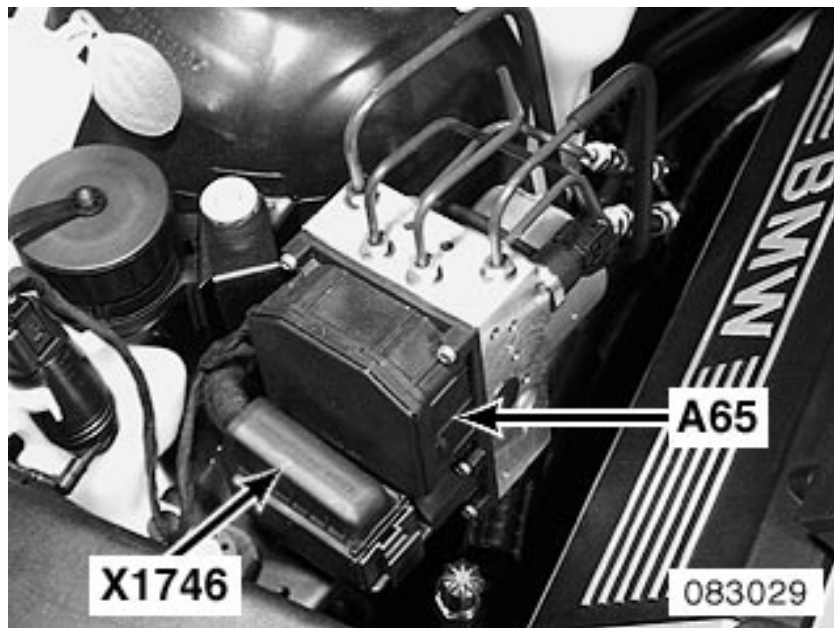

RH side of engine compartment

A65

ABS/DSC control module

X1746

Component connector (43-pin, Black), ABS/DSC control module

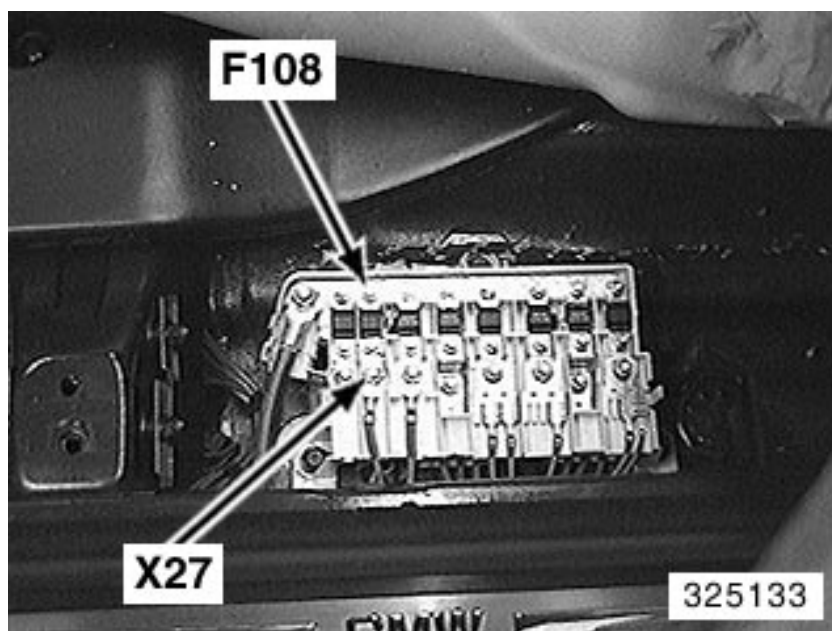

RH side of RH footwell under carpet

F108

Fuse F108

X27

Cable shoe Fuse output

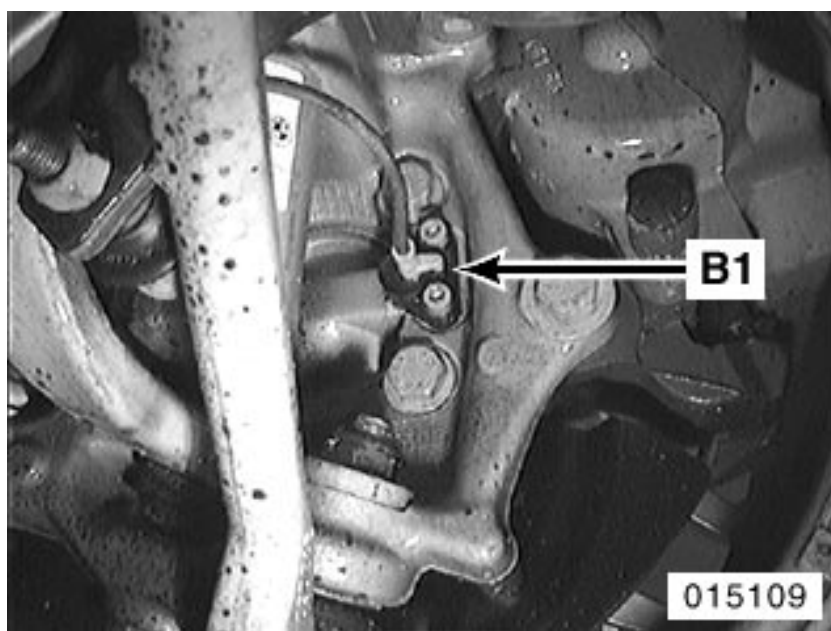

on right front wheel inside of wheel hub

B1

Right front speed sensor

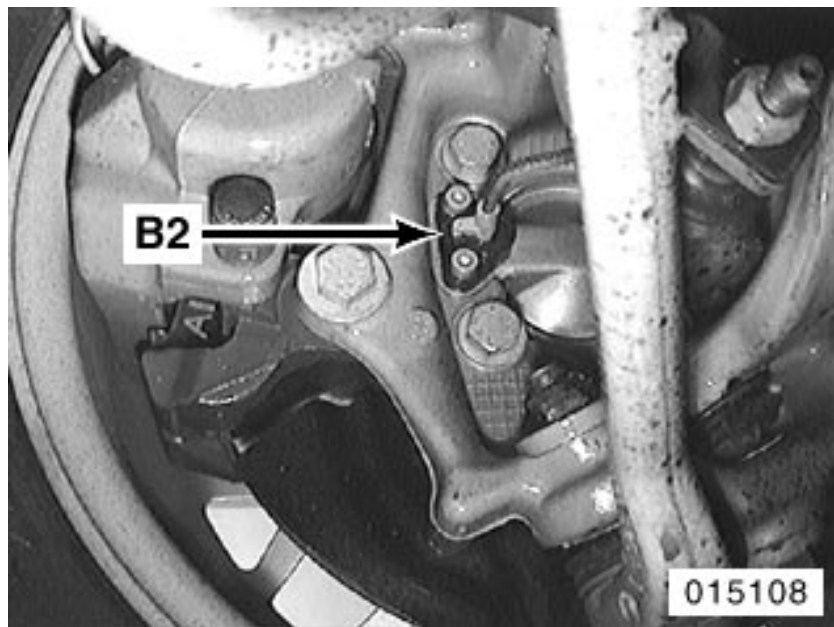

on left front wheel inside of wheel hub

B2

Left front speed sensor

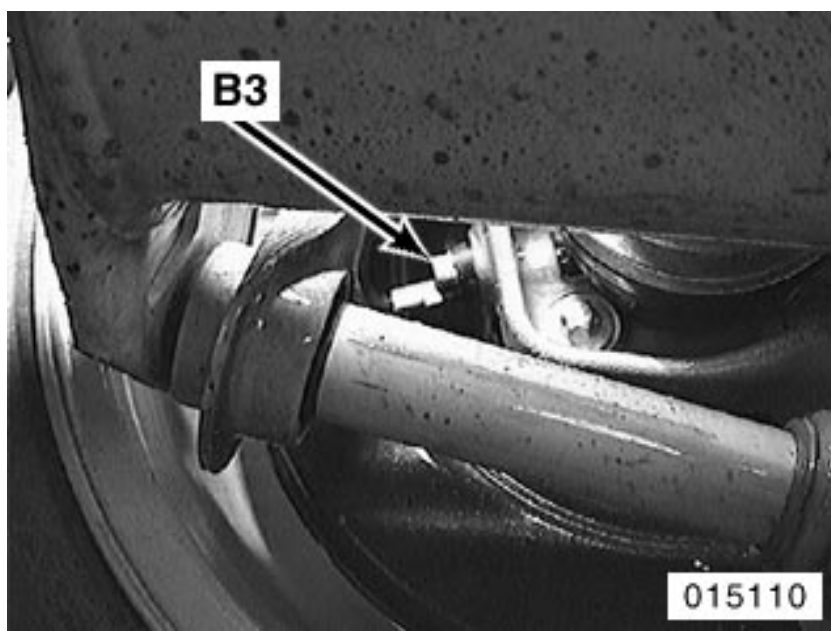

on right rear wheel inside of wheel hub

B3

Right rear speed sensor

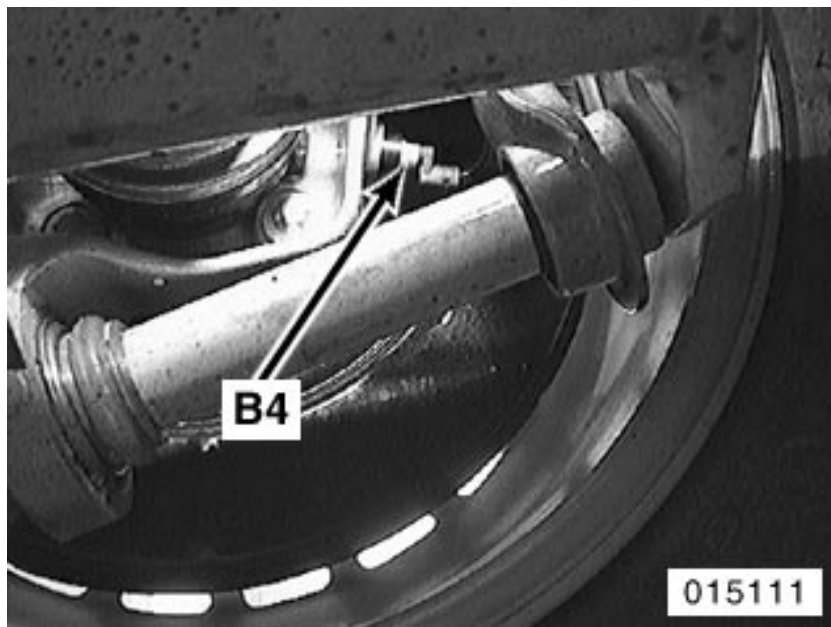

on left rear wheel inside of wheel hub

B4

Left rear speed sensor

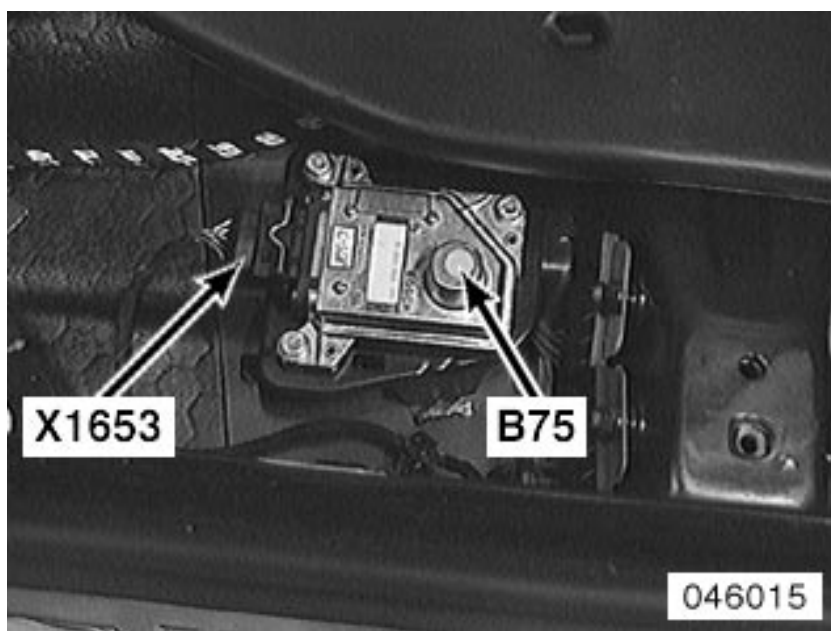

LH side of LH footwell under carpet

B75

rpm rate sensor

X1653

Component connector (5-pin, Black), rpm rate sensor

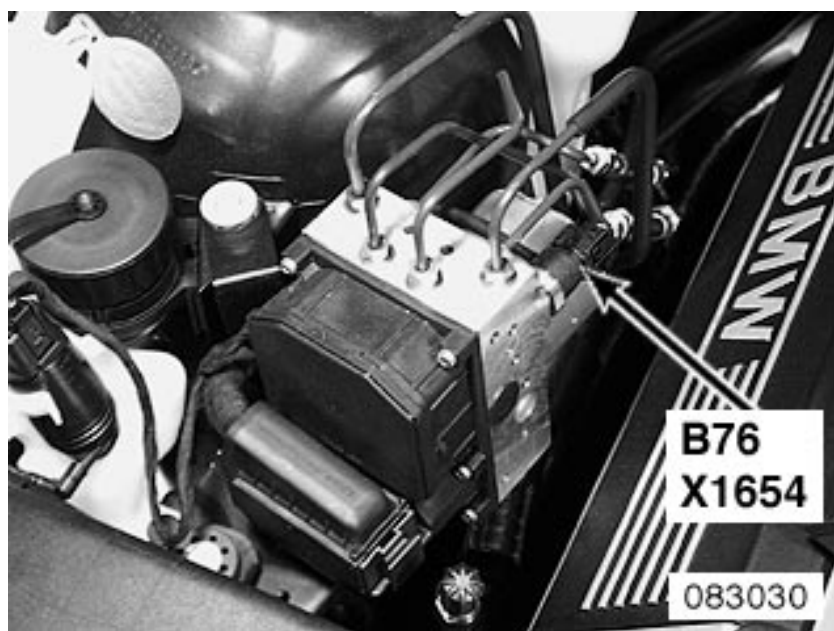

RH side of engine compartment

B76

Pressure sensor

X1654

Component connector (3-pin, Black), Pressure sensor

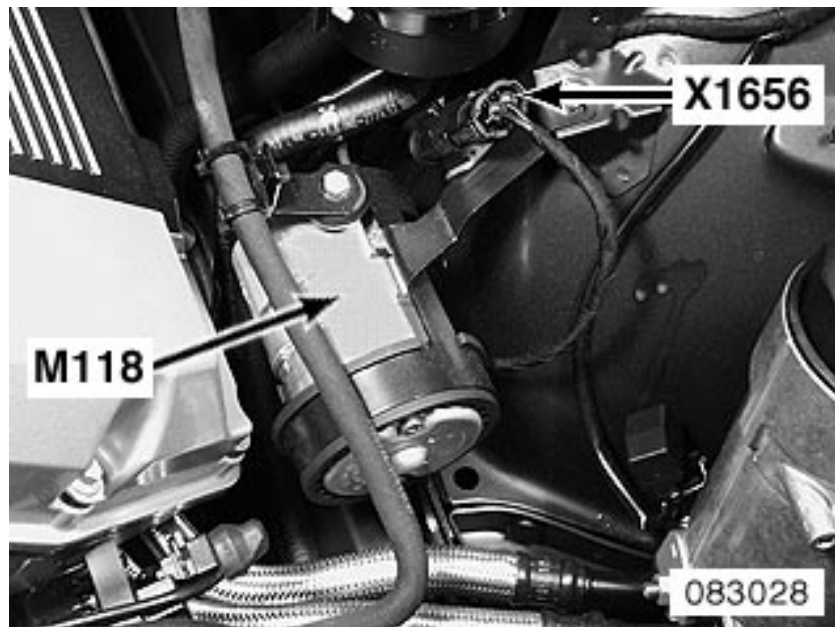

LH side of engine compartment

M118

Precharge pump

X1656

Component connector (2-pin, Black), Precharge pump

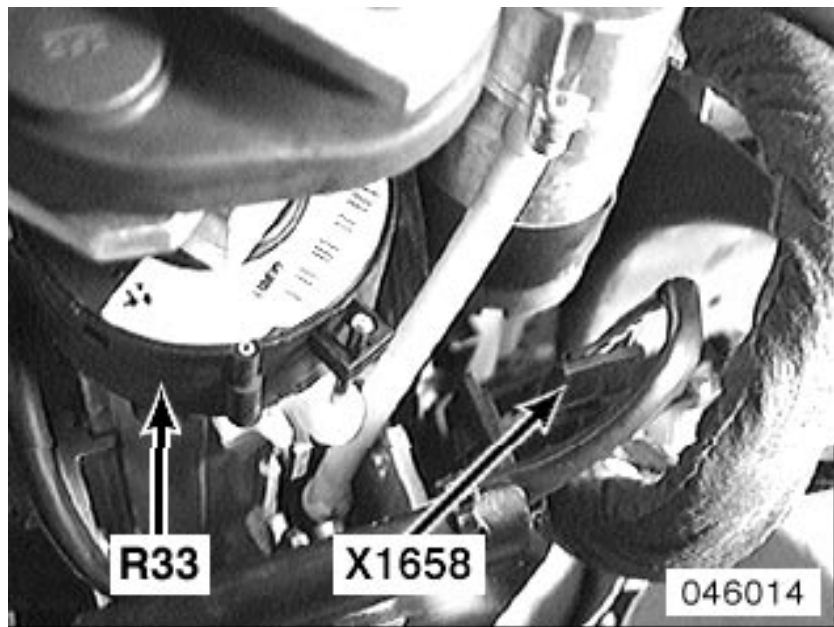

on steering column

R33

Steering angle sensor

X1658

In-line connector (6-pin, Black), Steering angle sensor

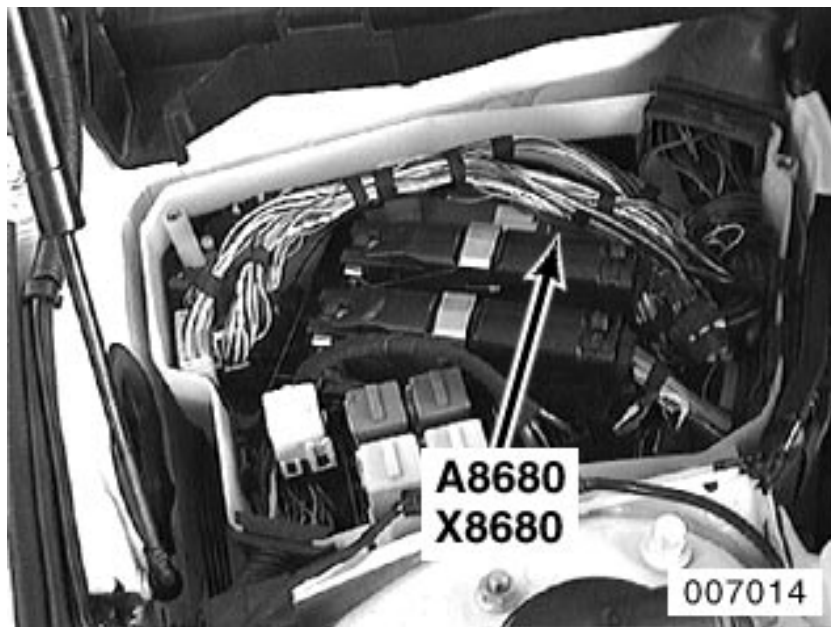

rear RH side of engine compartment in E-Box

A8680

Fuse carrier, engine electronics

X8680

Component connector (10 -pin, Black), Fuse carrier, engine electronics

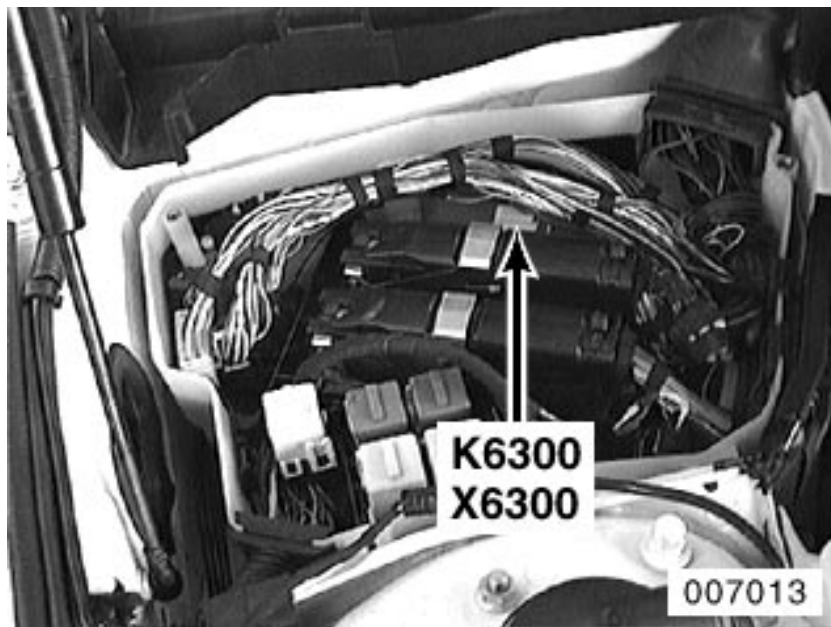

rear RH side of engine compartment in E-Box

K6300

Engine control module relay

X6300

Component connector (9 -pin, Black), Engine control module relay

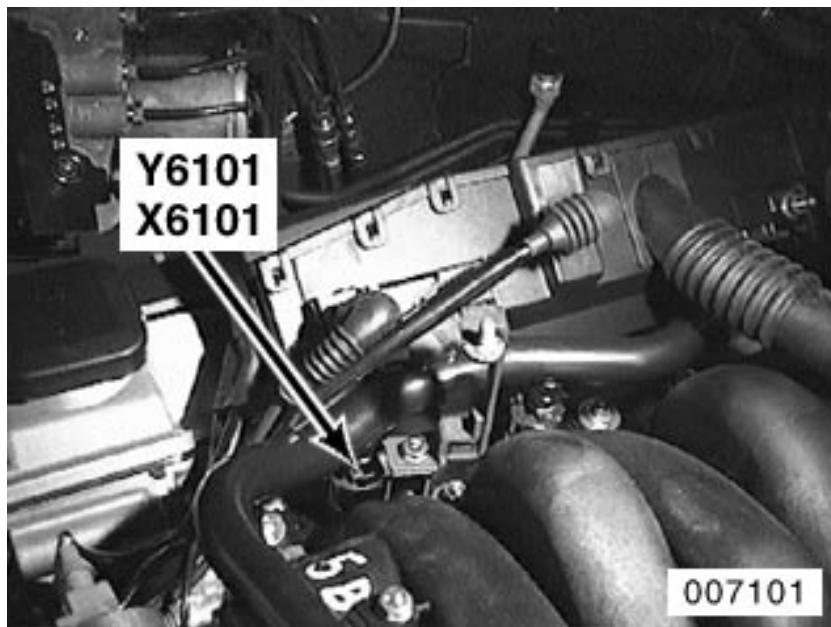

RH side of engine front

Y6101

Cyl. 1 fuel injection valve

X6101

Component connector (2 -pin, Black), Cyl. 1 fuel injection valve

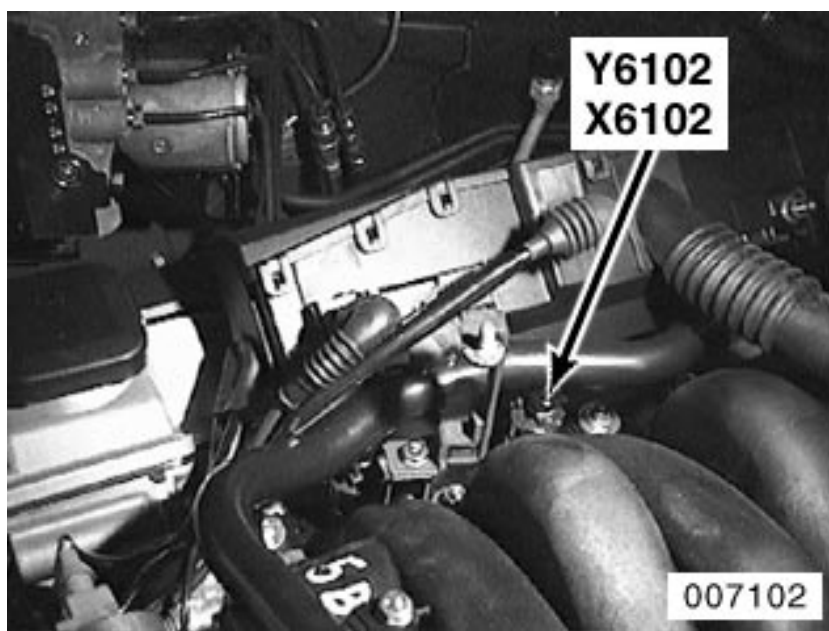

RH side of engine front

Y6102

Cyl. 2 fuel injection valve

X6102

Component connector (2 -pin, Black), Cyl. 2 fuel injection valve

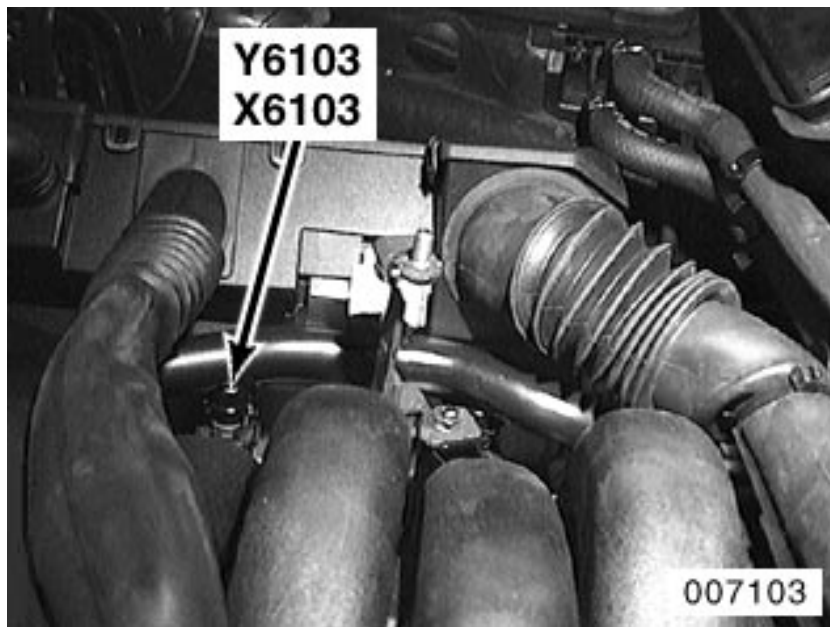

RH side of engine front

Y6103

Cyl. 3 fuel injection valve

X6103

Component connector (2 -pin, Black), Cyl. 3 fuel injection valve

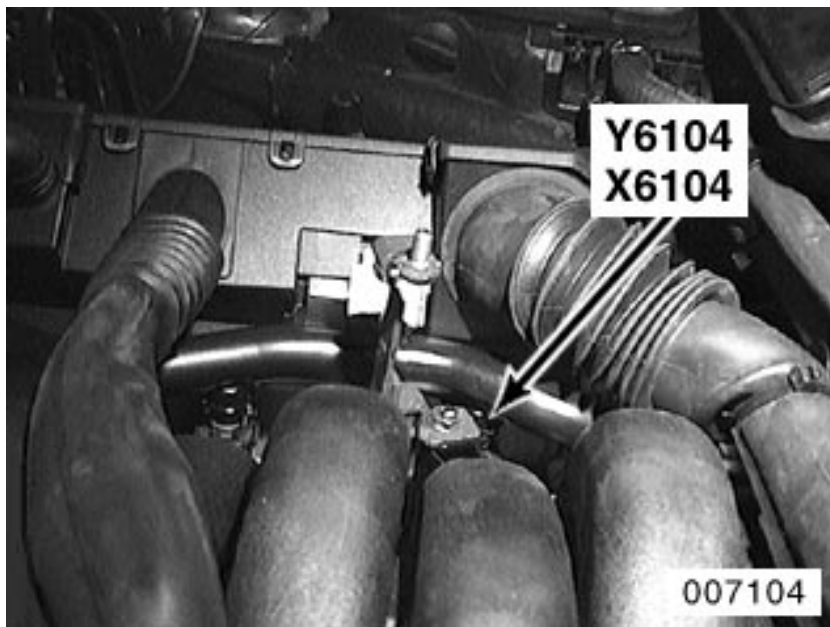

RH side of engine front

Y6104

Cyl. 4 fuel injection valve

X6104

Component connector (2 -pin, Black), Cyl. 4 fuel injection valve

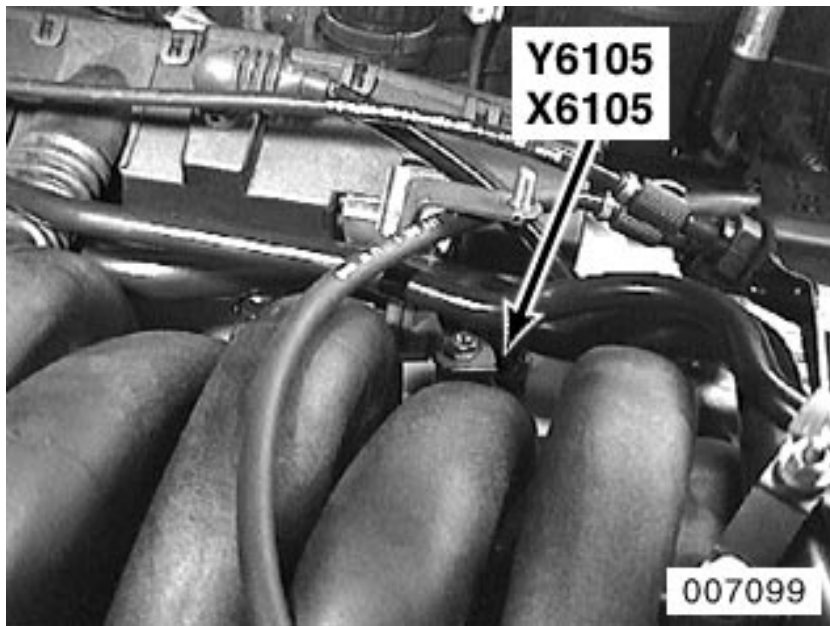

LH side of engine front

Y6105

Cyl. 5 fuel injection valve

X6105

Component connector (2 -pin, Black), Cyl. 5 fuel injection valve

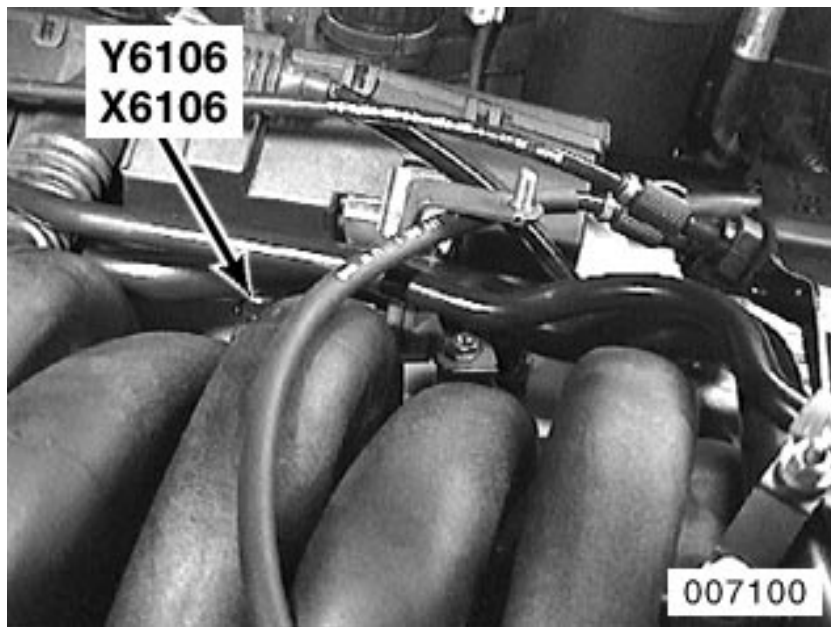

LH side of engine front

Y6106

Cyl. 6 fuel injection valve

X6106

Component connector (2 -pin, Black), Cyl. 6 fuel injection valve

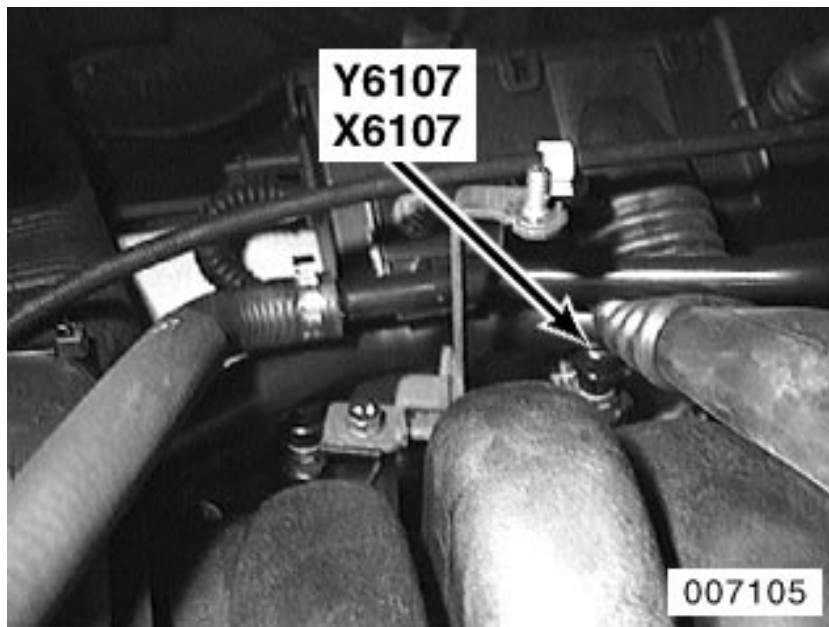

LH side of engine front

Y6107

Cyl. 7 fuel injection valve

X6107

Component connector (2 -pin, Black), Cyl. 7 fuel injection valve

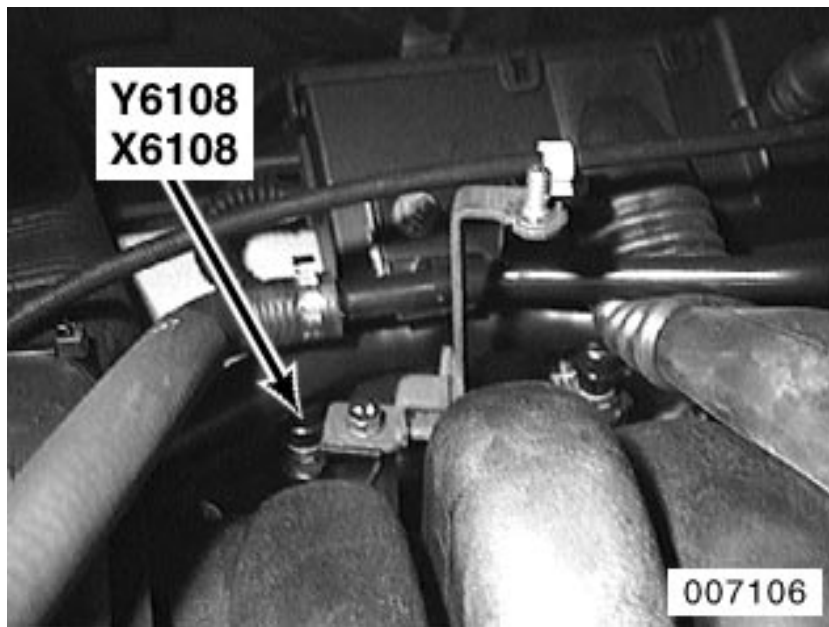

LH side of engine front

Y6108

Cyl. 8 fuel injection valve

X6108

Component connector (2 -pin, Black), Cyl. 8 fuel injection valve

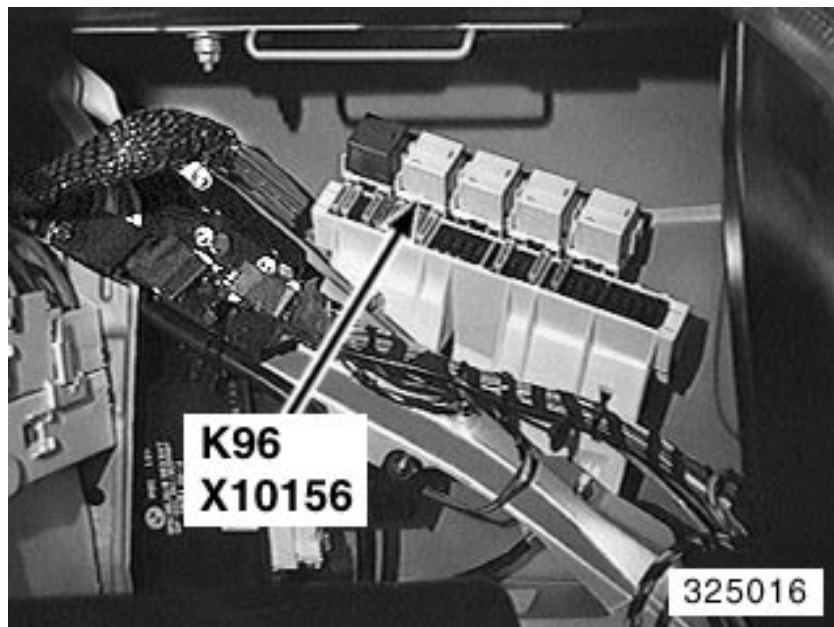

in RH side of luggage compartment

K96

Fuel pump relay

X10156

Component connector (9 -pin, Black), Fuel pump relay

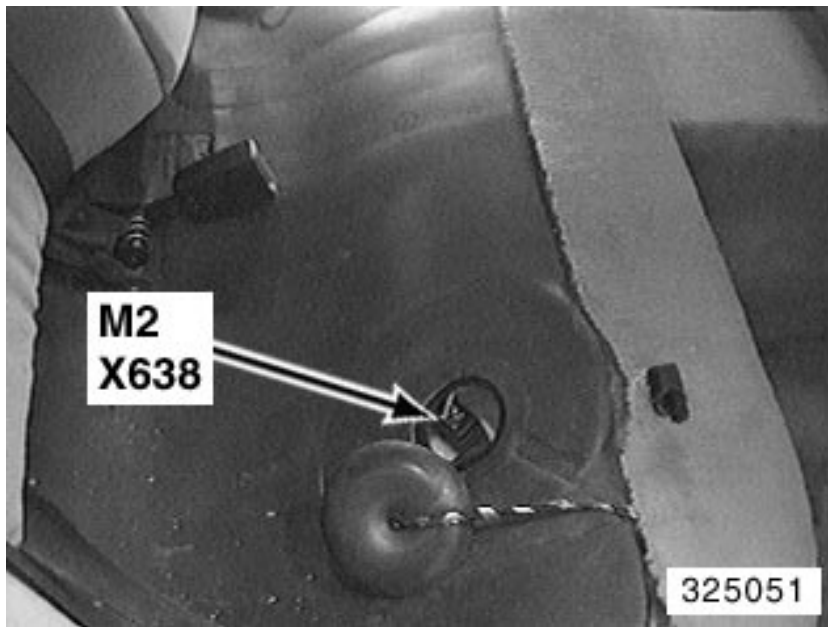

underside of rear seat right

M2

Electrical fuel pump (EKP I)

X638

Component connector (6 -pin, Black), Electrical fuel pump (EKP I)

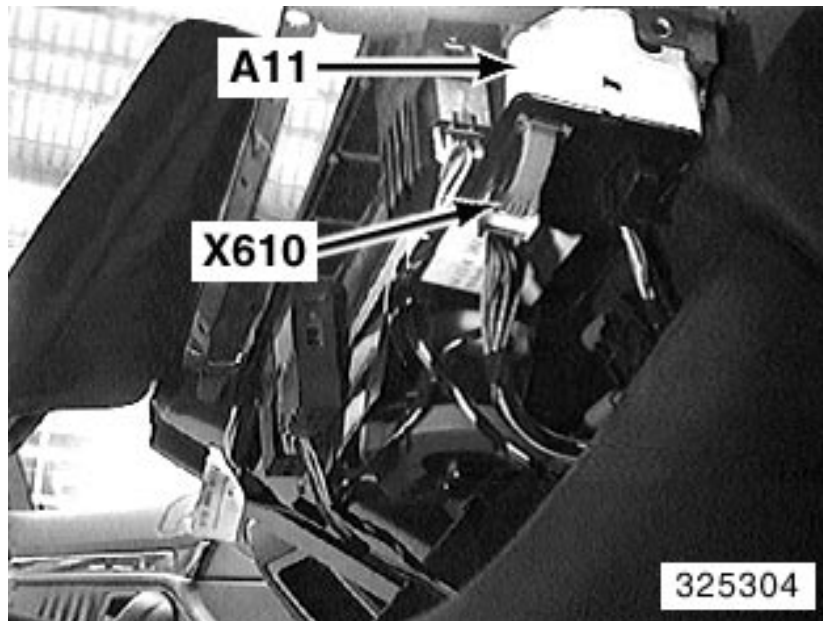

center console

A11

Heating and A/C control module

X610

Component connector (26 -pin, Blue), Heating and A/C control module

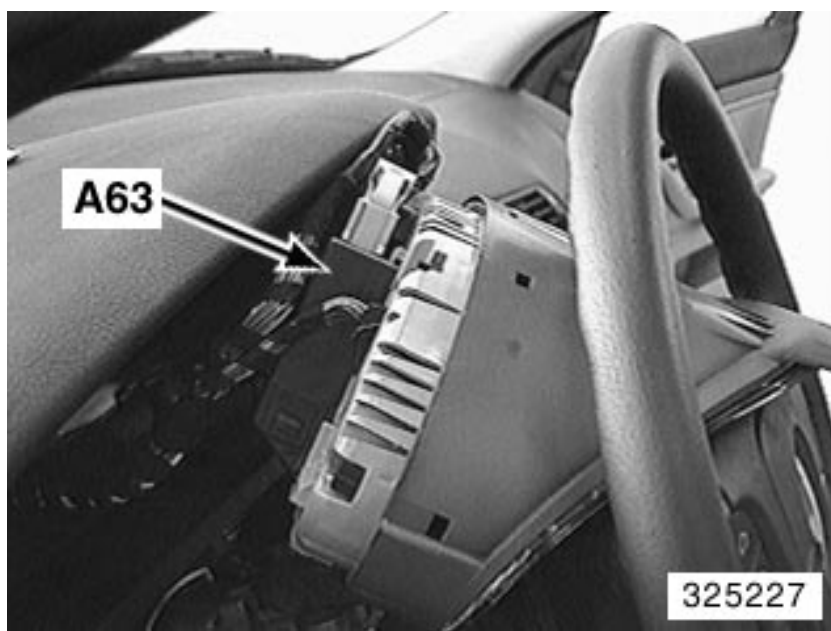

behind instrument cluster

A63

Integrated instrument cluster control module (IKE)



on steering column

S2

Ignition switch

X33

Component connector (11 -pin, Black), Ignition switch

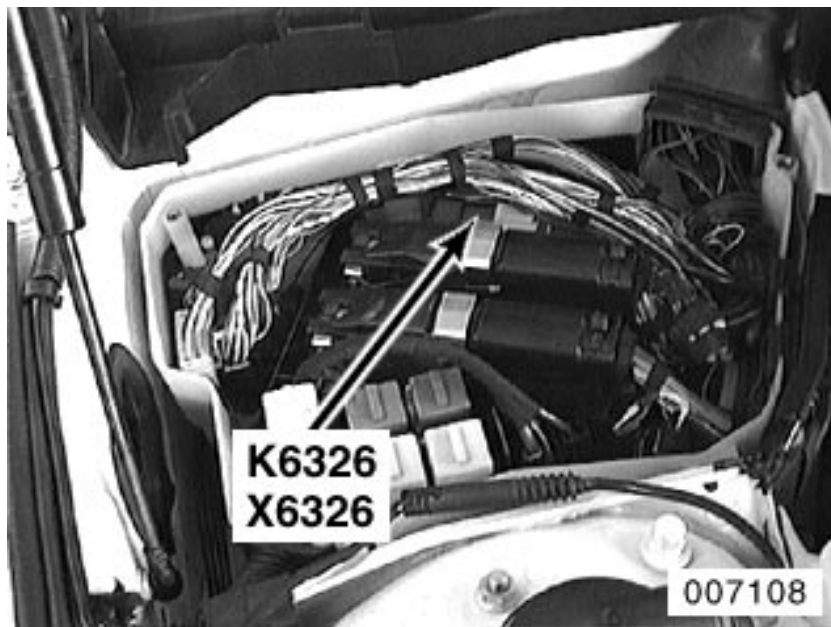

rear RH side of engine compartment in E-Box

K6326

Unloader relay terminal 15

X6326

Component connector (9 -pin, Black), Unloader relay terminal 15

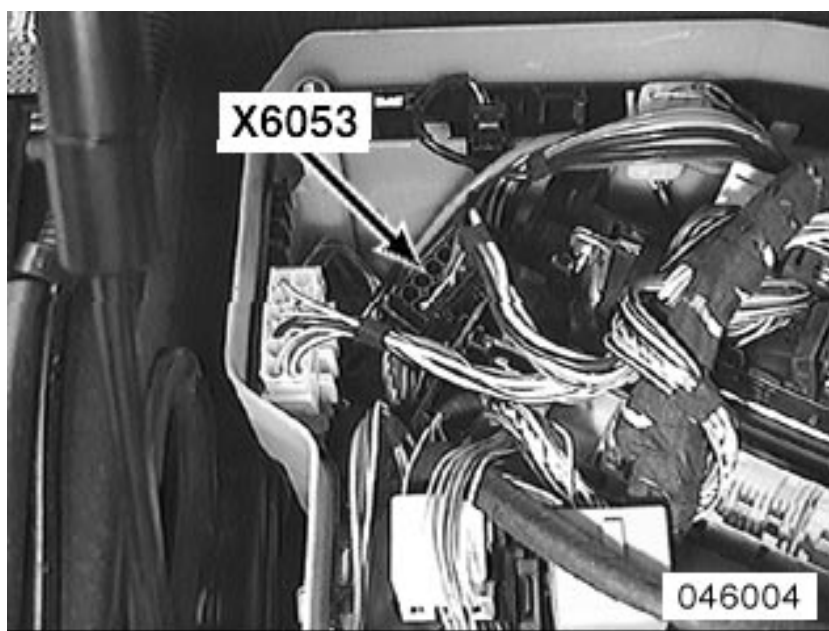

rear RH side of engine compartment in E-Box

X6053

In-line connector (12-pin, Black), Engine wiring harness

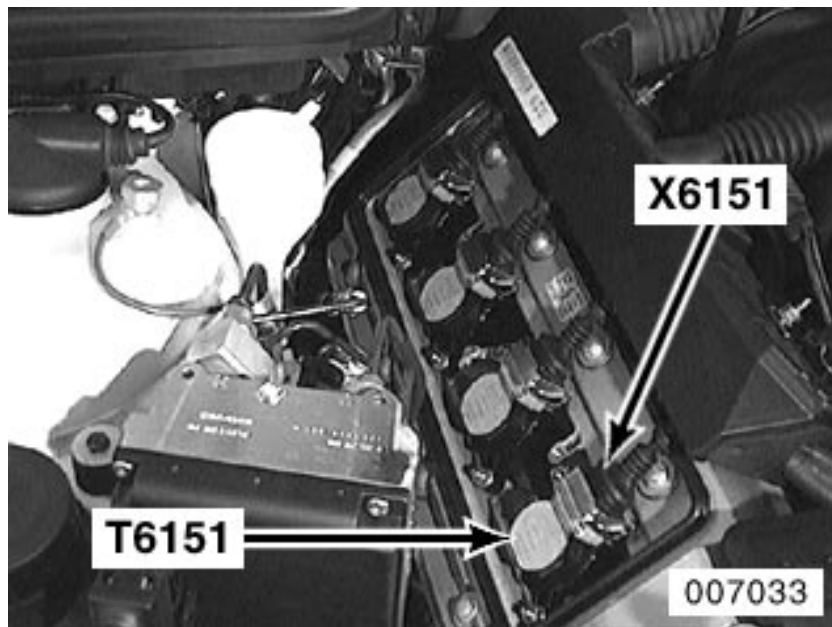

RH side of engine

T6151

Cyl. 1 ignition coil

X6151

Component connector (3 -pin, Black), Cyl. 1 ignition coil

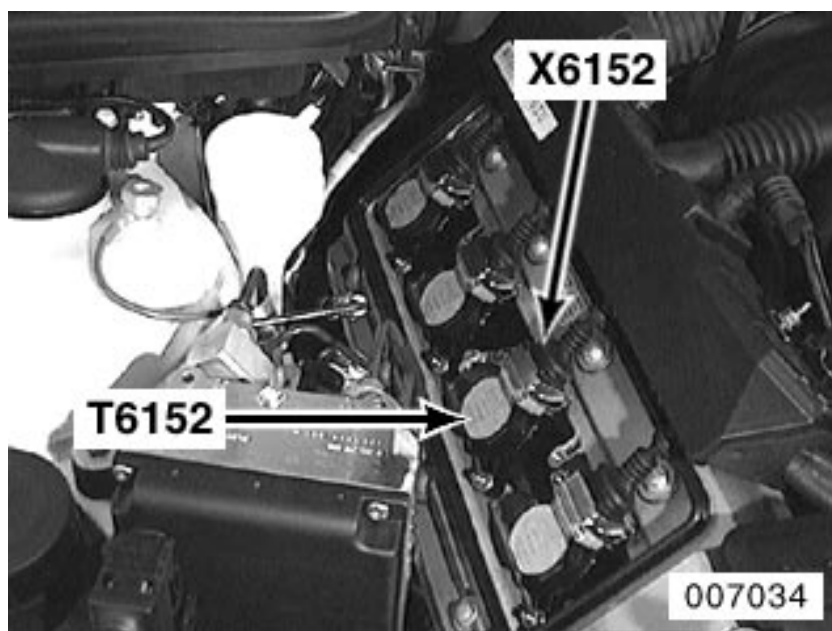

RH side of engine

T6152

Cyl. 2 ignition coil

X6152

Component connector (3 -pin, Black), Cyl. 2 ignition coil

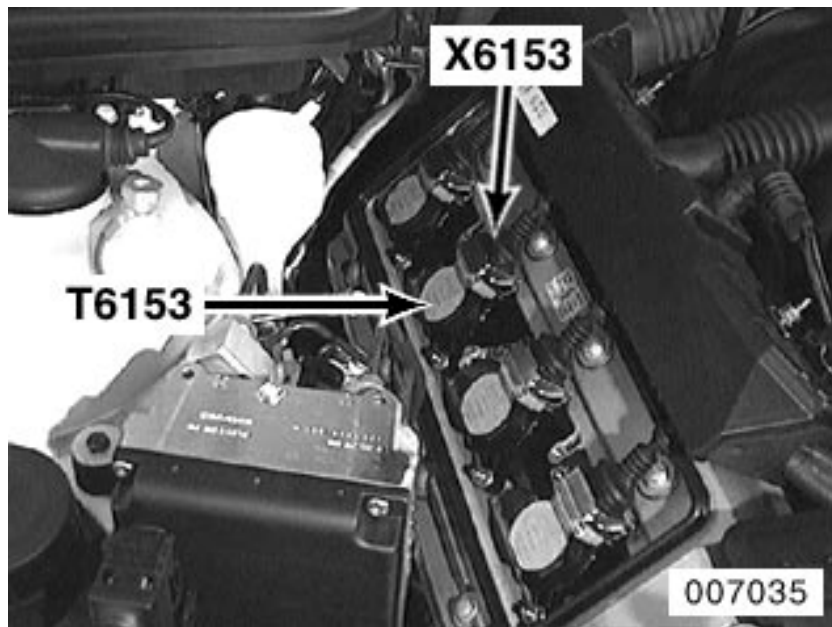

RH side of engine

T6153

Cyl. 3 ignition coil

X6153

Component connector (3 -pin, Black), Cyl. 3 ignition coil

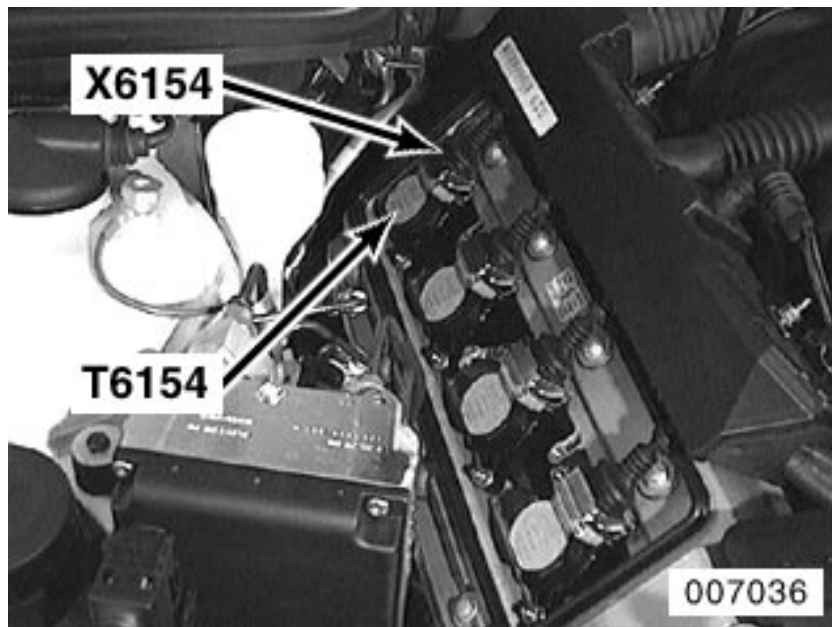

RH side of engine

T6154

Cyl. 4 ignition coil

X6154

Component connector (3 -pin, Black), Cyl. 4 ignition coil

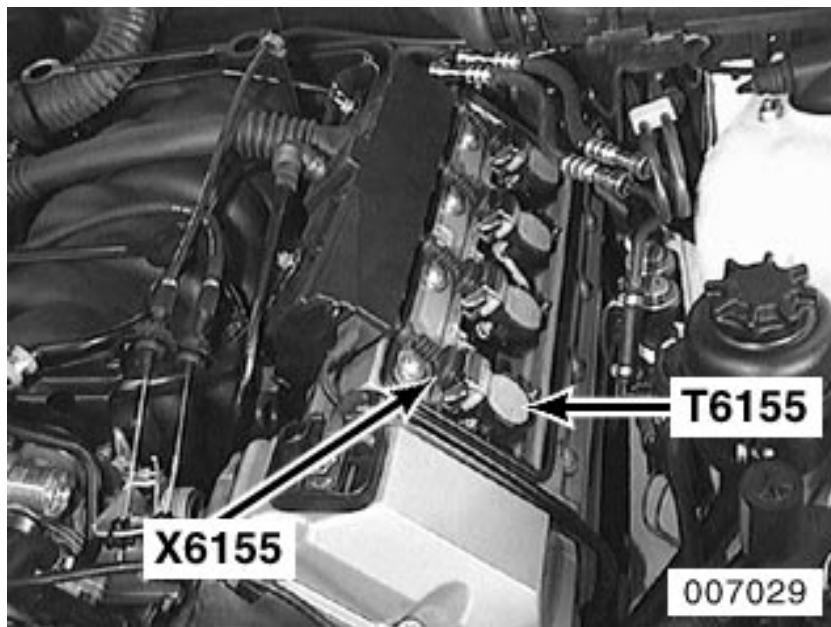

LH side of engine

T6155

Cyl. 5 ignition coil

X6155

Component connector (3 -pin, Black), Cyl. 5 ignition coil

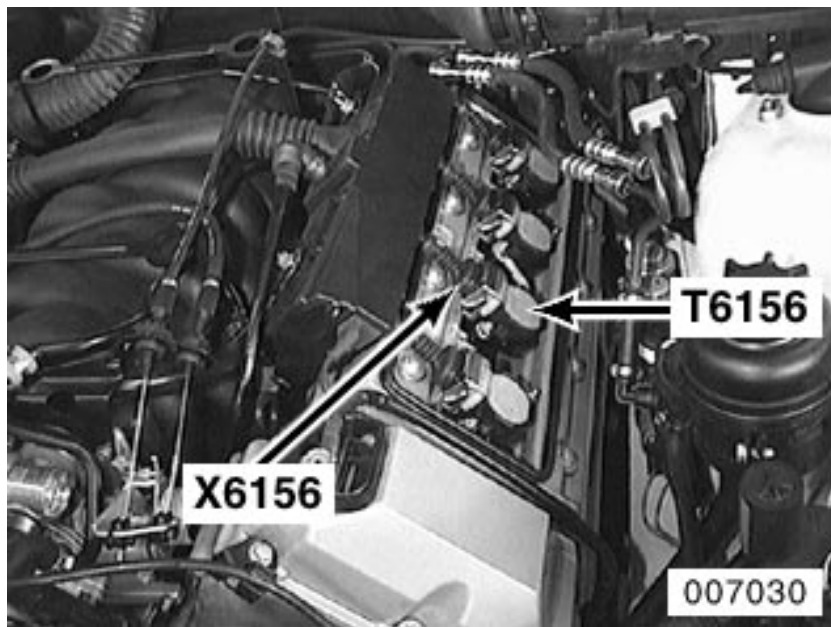

LH side of engine

T6156

Cyl. 6 ignition coil

X6156

Component connector (3 -pin, Black), Cyl. 6 ignition coil

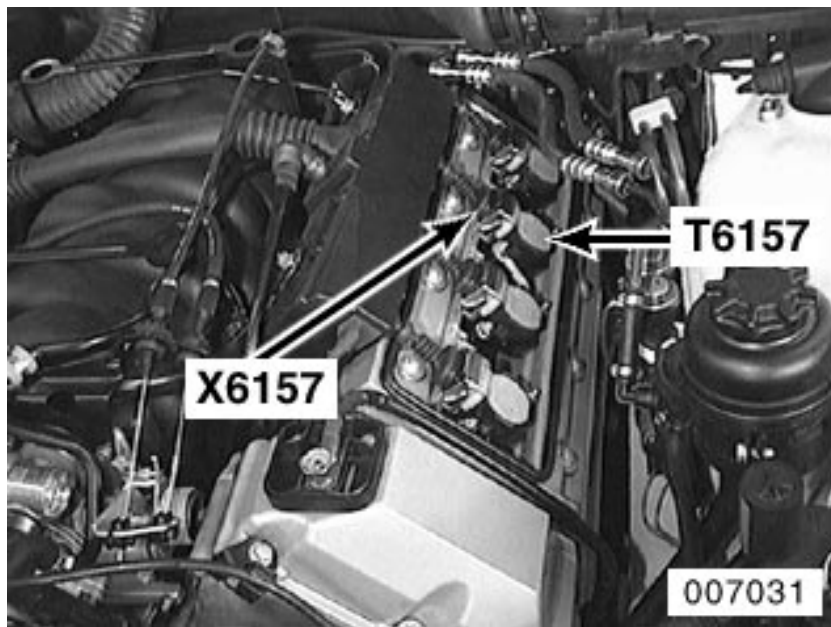

LH side of engine

T6157

Cyl. 7 ignition coil

X6157

Component connector (3 -pin, Black), Cyl. 7 ignition coil

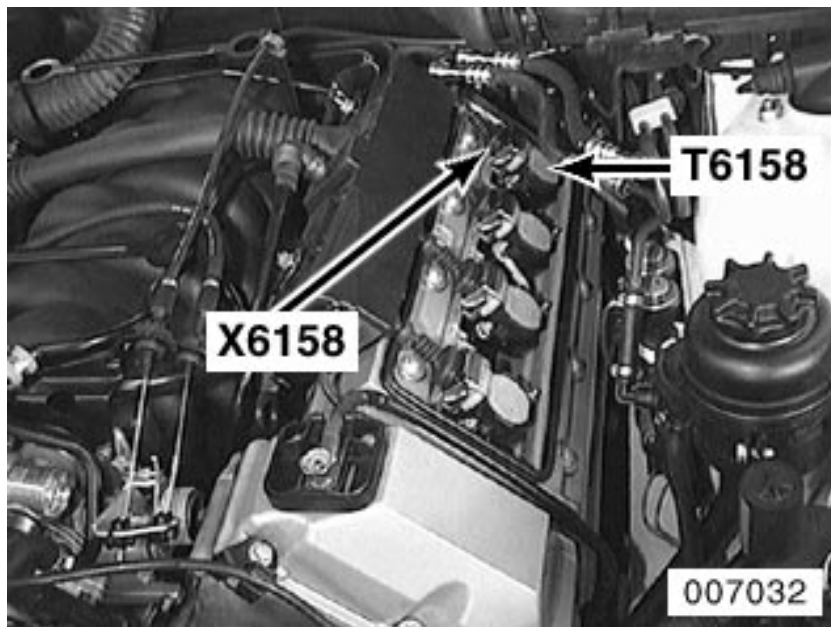

LH side of engine

T6158

Cyl. 8 ignition coil

X6158

Component connector (3 -pin, Black), Cyl. 8 ignition coil

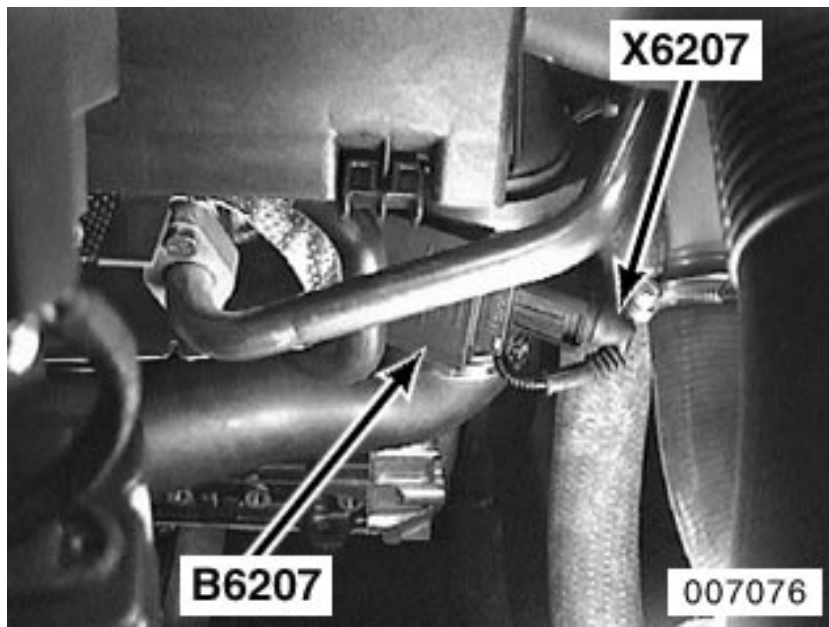

lower RH side of engine front

B6207

Hot-film air mass meter

X6207

Component connector (4 -pin, Black), Hot-film air mass meter

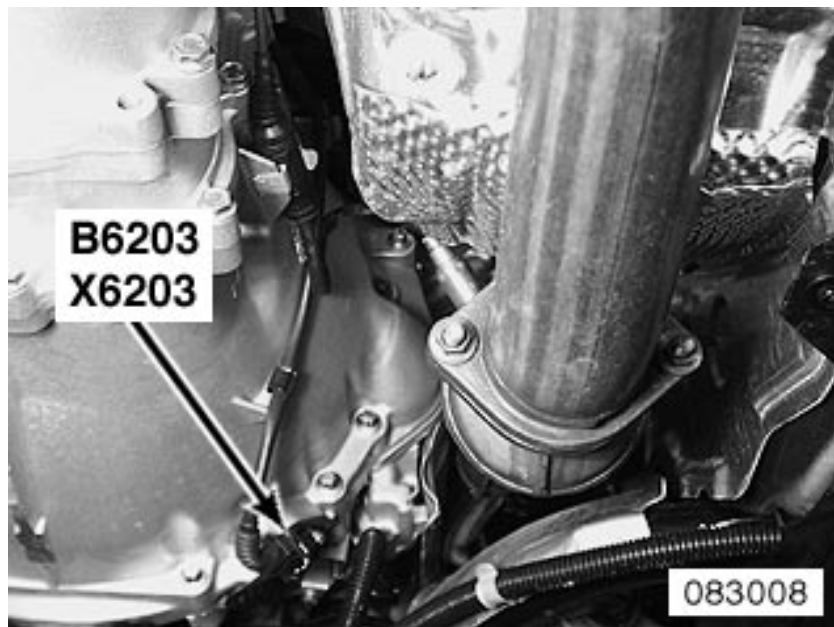

on RH side of transmission

B6203

Crankshaft position/RPM sensor

X6203

Component connector (3-pin, Black), Crankshaft position/RPM sensor

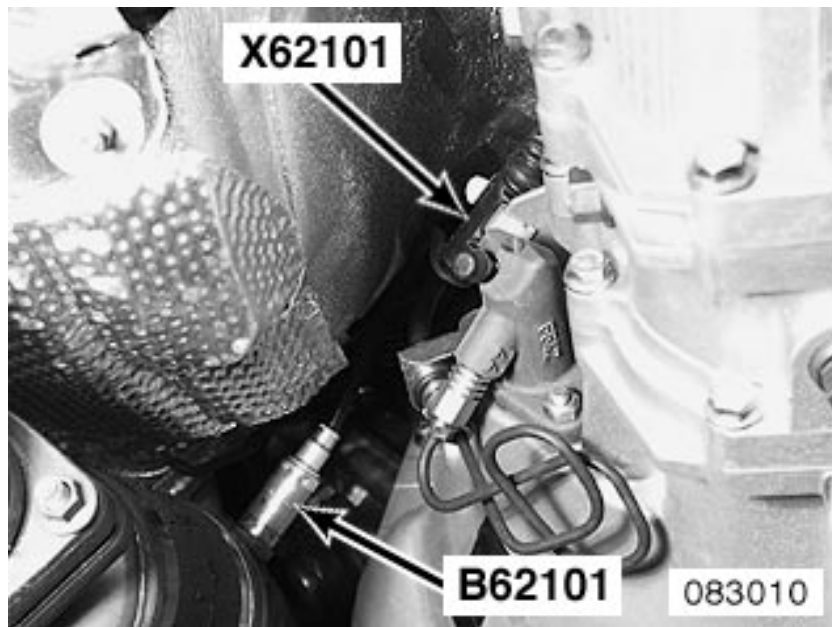

on LH side of transmission

B62101

Heated oxygen sensor I in front of catalytic converter

X62101

In-line connector (4-pin, Black), Heated oxygen sensor I in front of catalytic converter

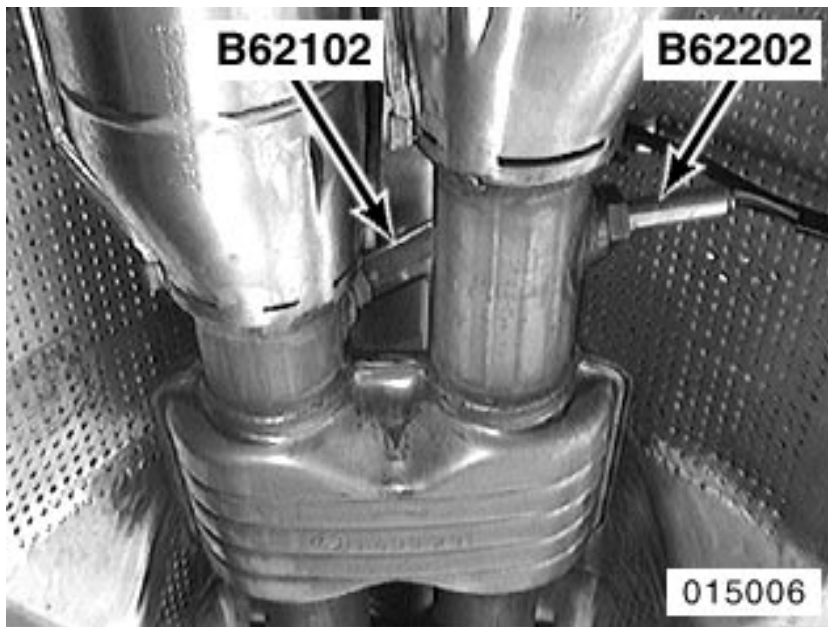

exhaust center

B62102

Heated oxygen sensor I behind catalytic converter

B62202

Heated oxygen sensor II behind catalytic converter

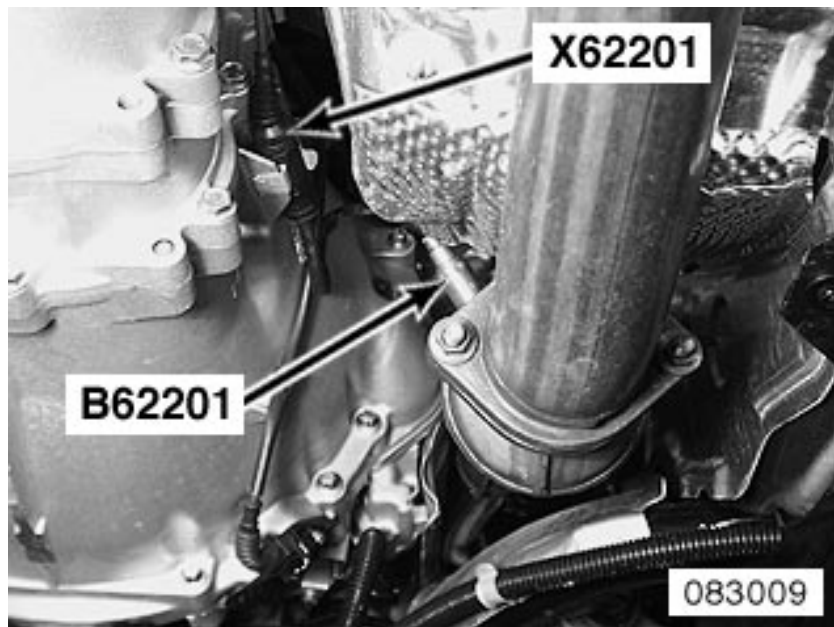

on RH side of transmission

B62201

Heated oxygen sensor II in front of catalytic converter

X62201

In-line connector (4-pin, Black), Heated oxygen sensor II in front of catalytic converter

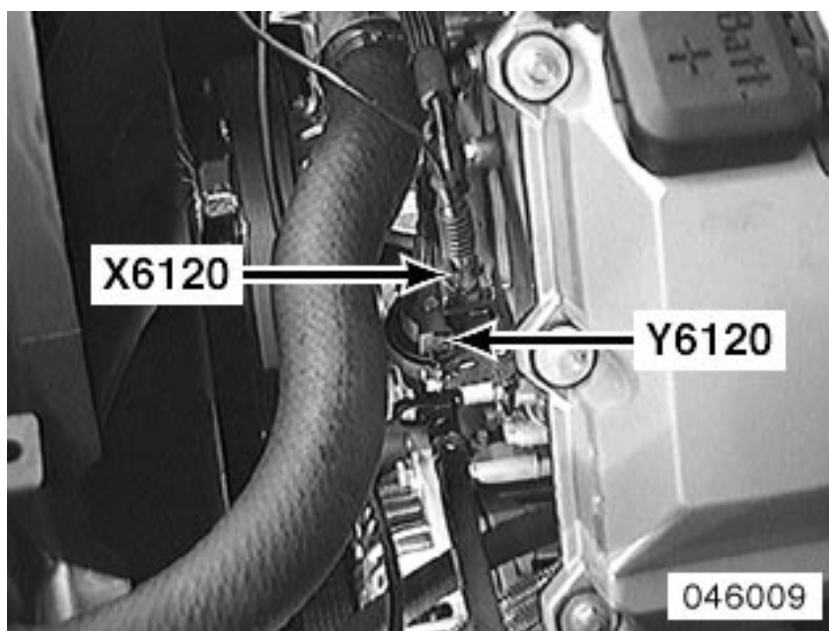

front of engine

Y6120

Evaporative emission valve

X6120

Component connector (2-pin, Black), Evaporative emission valve

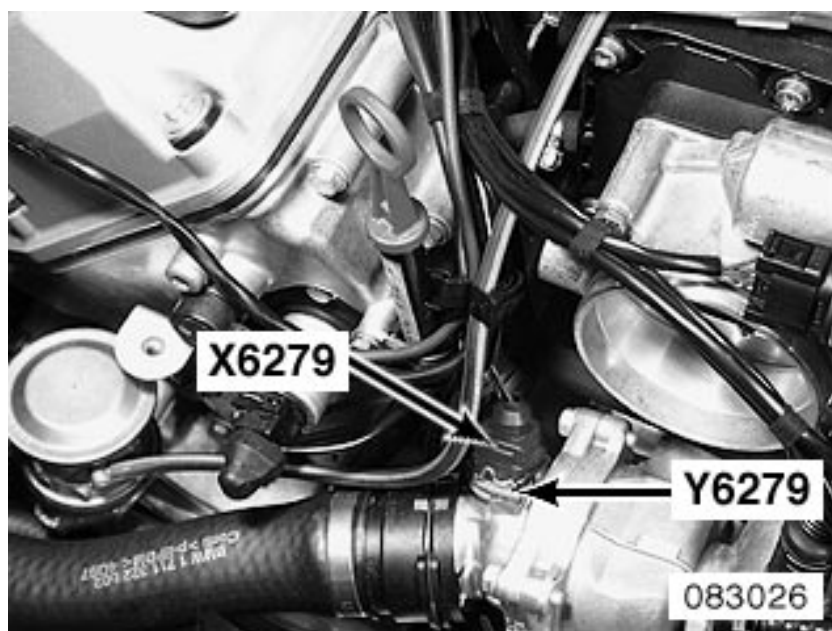

RH side of engine

Y6279

Characteristic map, cooling

X6279

Component connector (2-pin, Black), Characteristic map, cooling

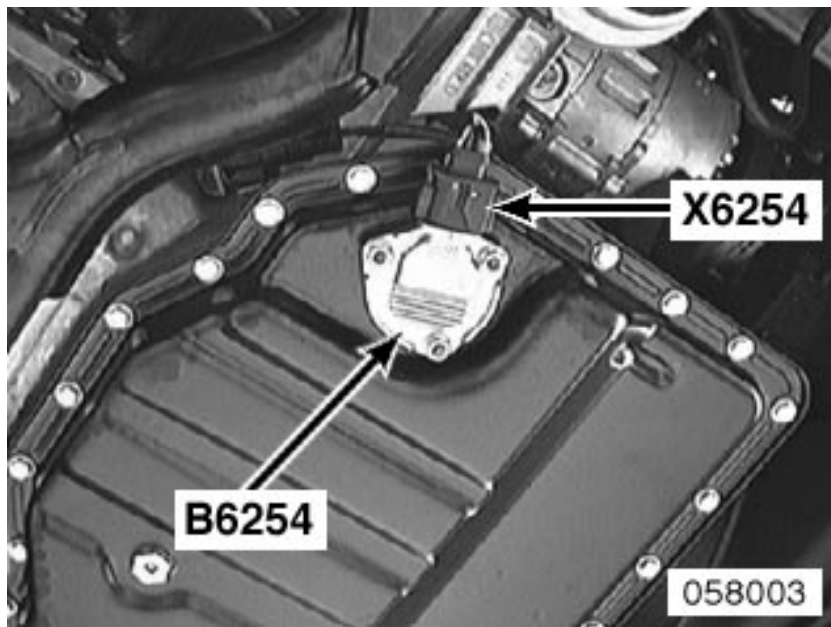

underside of oil pan

B6254

Oil level sensor

X6254

Component connector (3-pin, Black), Oil level sensor

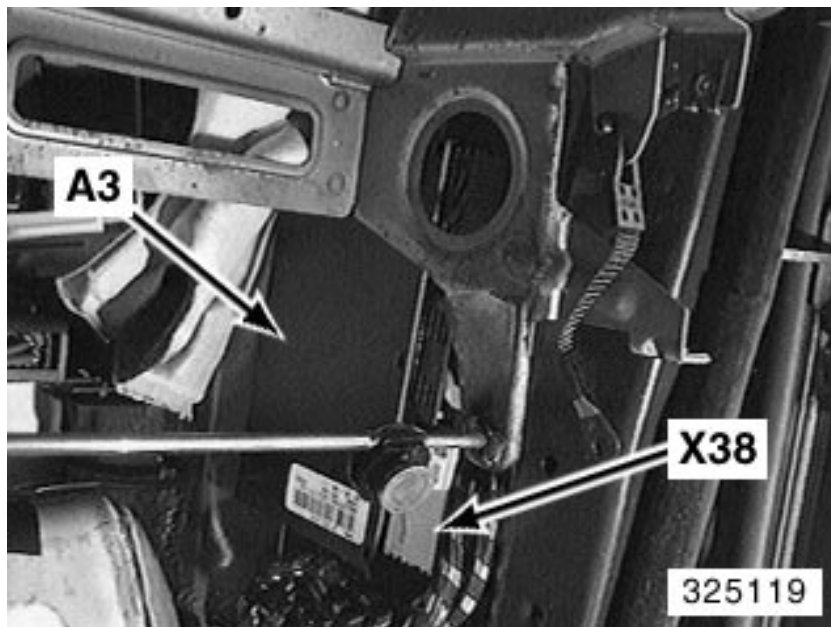

RH side of RH footwell

A3

Light module

X38

Component connector (15 -pin, White), Light module

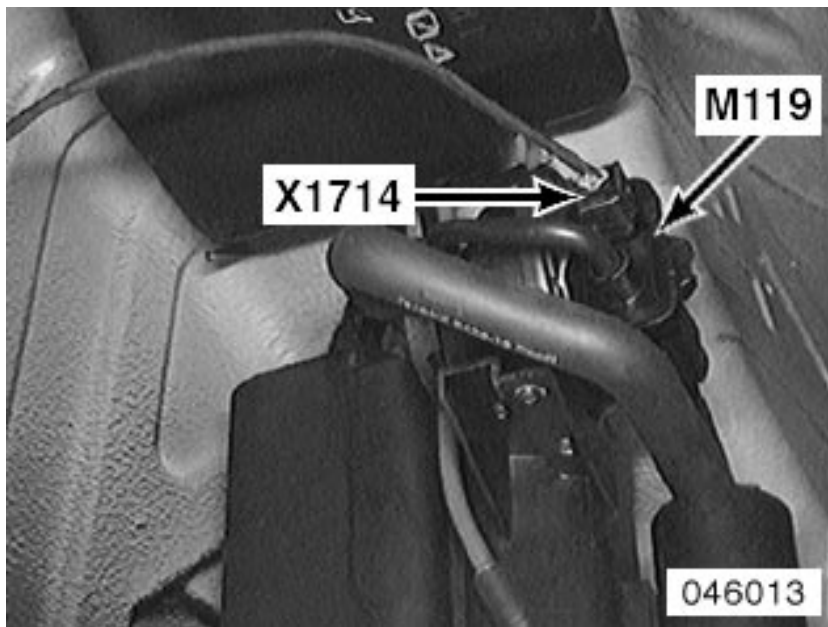

wheel well rear left

M119

Leakage diagnosis pump

X1714

In-line connector (3-pin, Natural), Leakage diagnosis pump

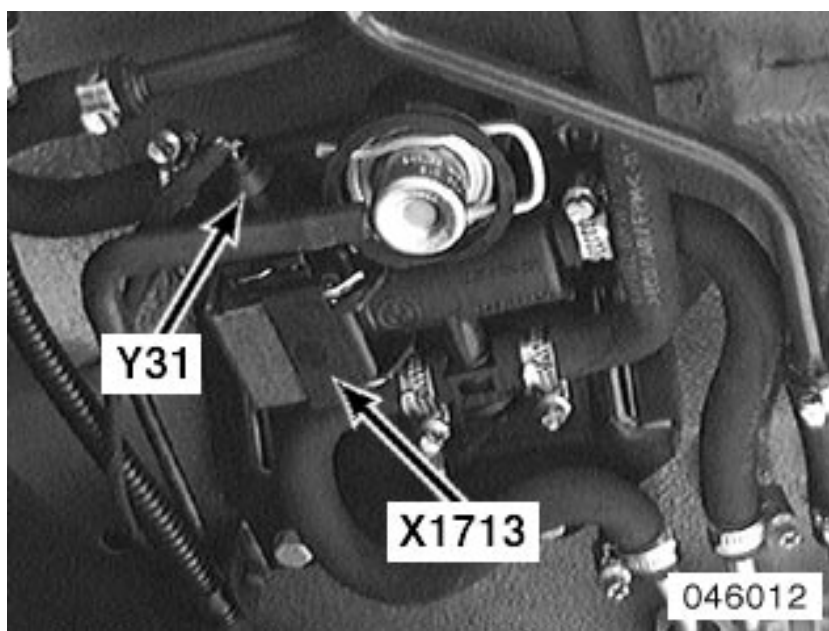

under LH front of vehicle

Y31

Fuel changeover circuit

X1713

Component connector (2-pin, Black), Fuel changeover circuit

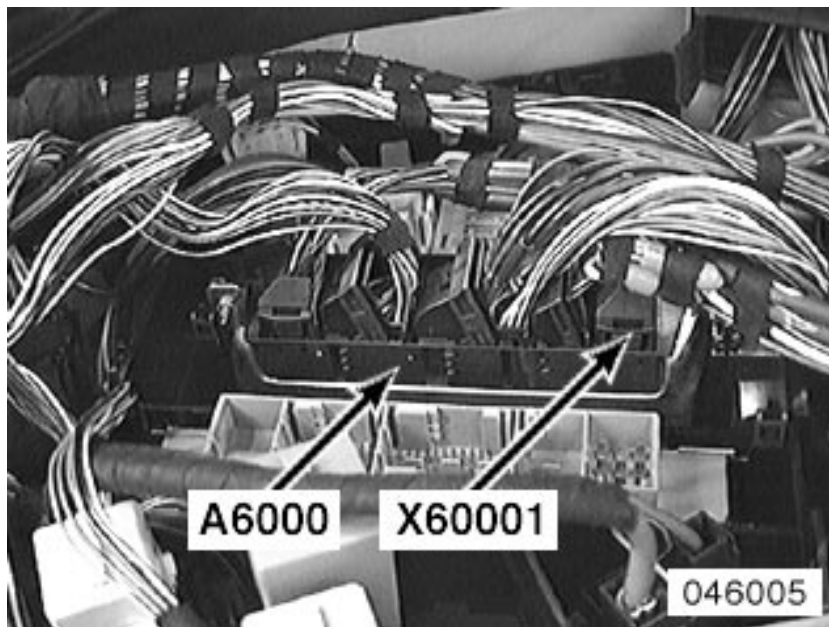

rear RH side of engine compartment in E-Box

A6000

Engine control module (DME)

X60001

Component connector (9-pin, Black), Engine control module (DME)

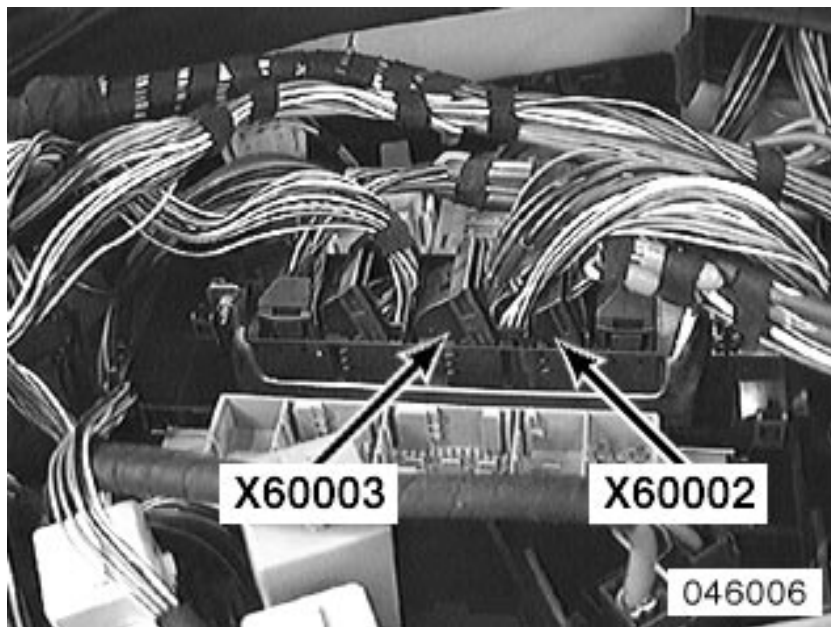

rear RH side of engine compartment in E-Box

X60002

Component connector (24-pin, Black), Engine control module (DME)

X60003

Component connector (52-pin, Black), Engine control module (DME)

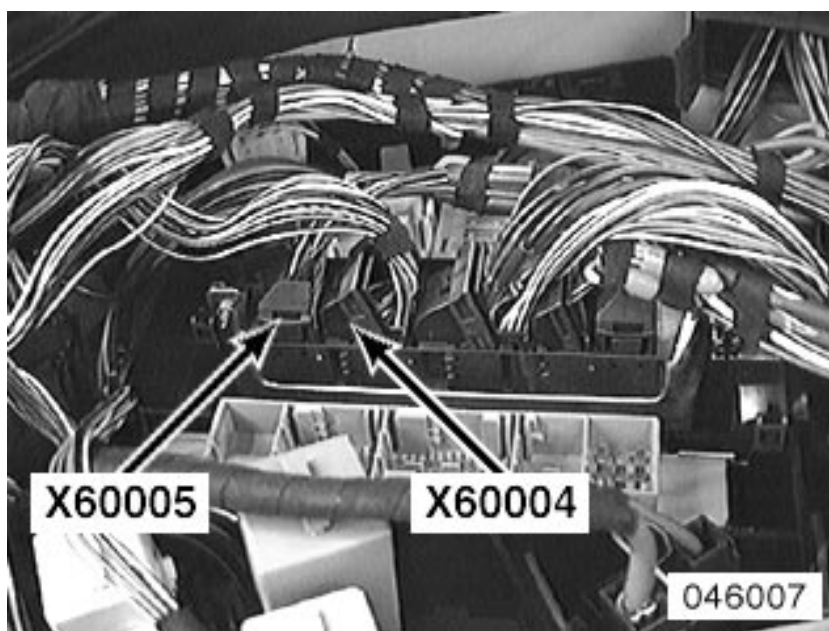

rear RH side of engine compartment in E-Box

X60004

Component connector (40-pin, Black), Engine control module (DME)

X60005

Component connector (9-pin, Black), Engine control module (DME)

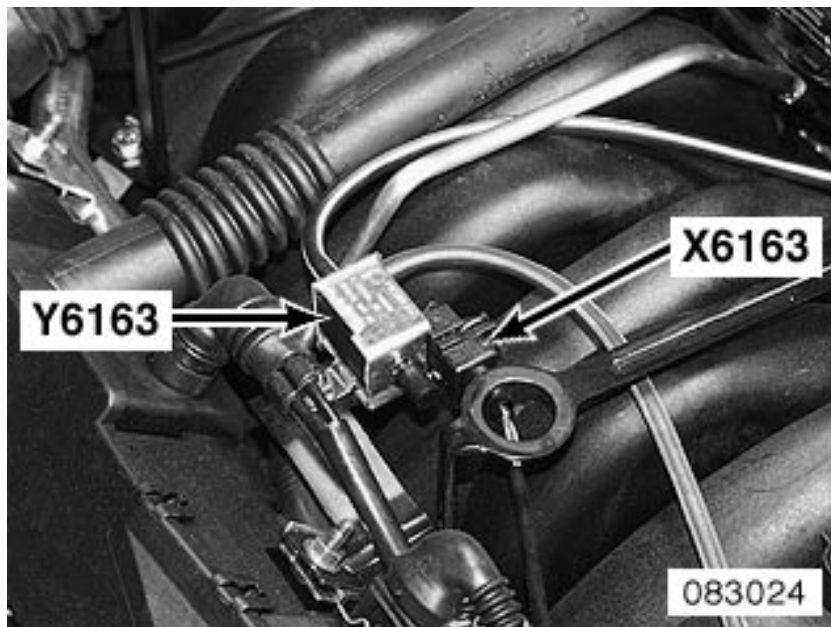

top center of engine

Y6163

Secondary air injection pump valve

X6163

Component connector (2-pin, Black), Secondary air injection pump valve



rear RH side of engine compartment in E-Box

K6304

Secondary air injection pump relay

X6304

Component connector (9-pin, Black), Secondary air injection pump relay

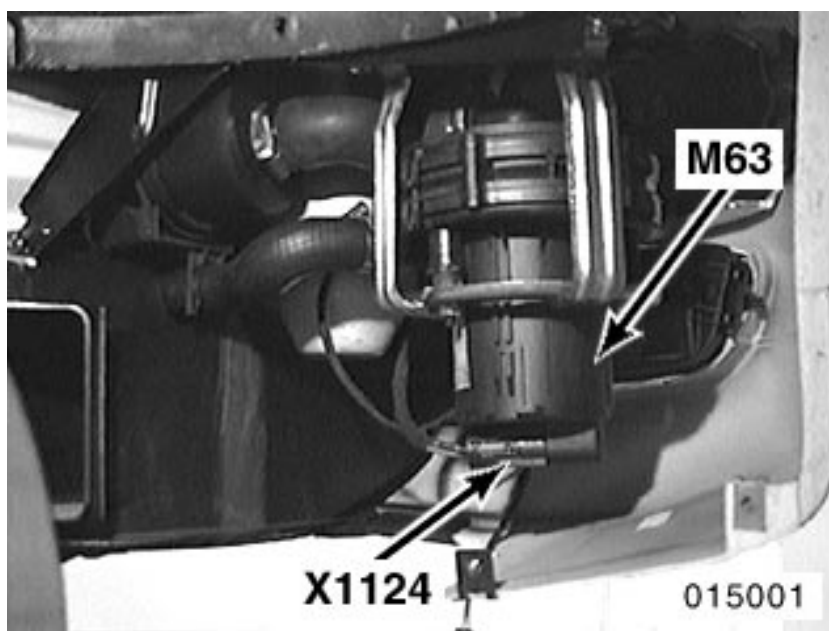

RH front of wheel well

M63

Secondary air injection pump

X1124

Component connector (2-pin, Yellow), Secondary air injection pump

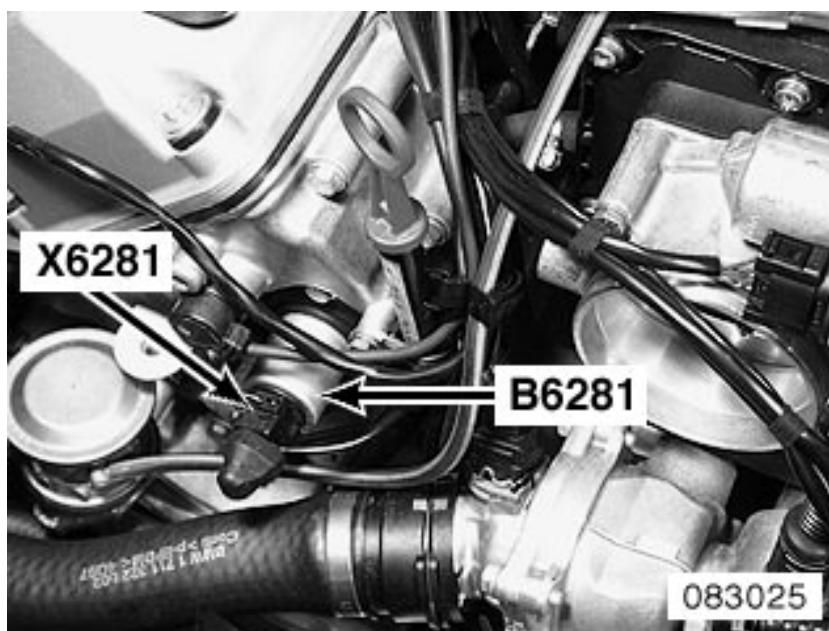

RH side of engine

B6281

VANOS inlet, cylinders 1-4

X6281

Component connector (2-pin, Black), VANOS inlet, cylinders 1-4

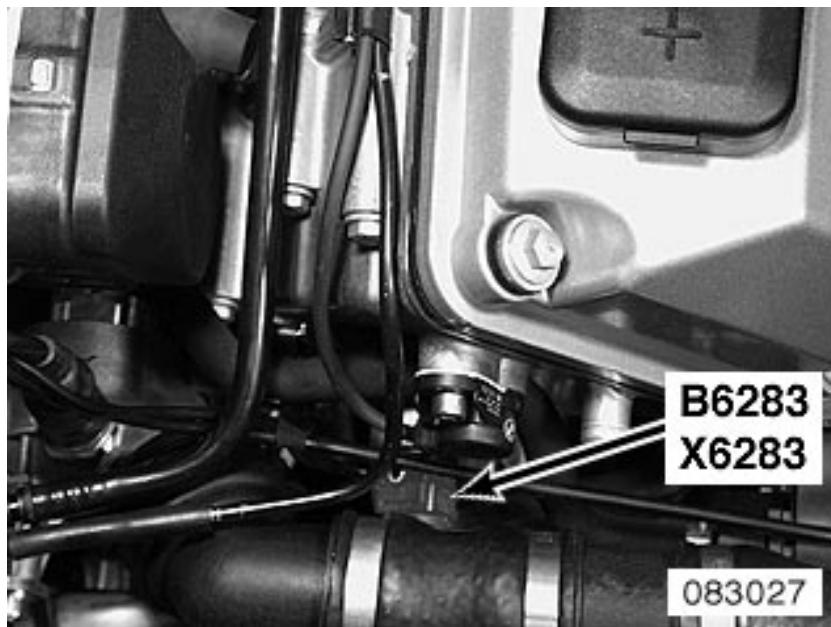

LH side of engine

B6283

VANOS inlet, cylinders 5-8

X6283

Component connector (2-pin, Black), VANOS inlet, cylinders 5-8

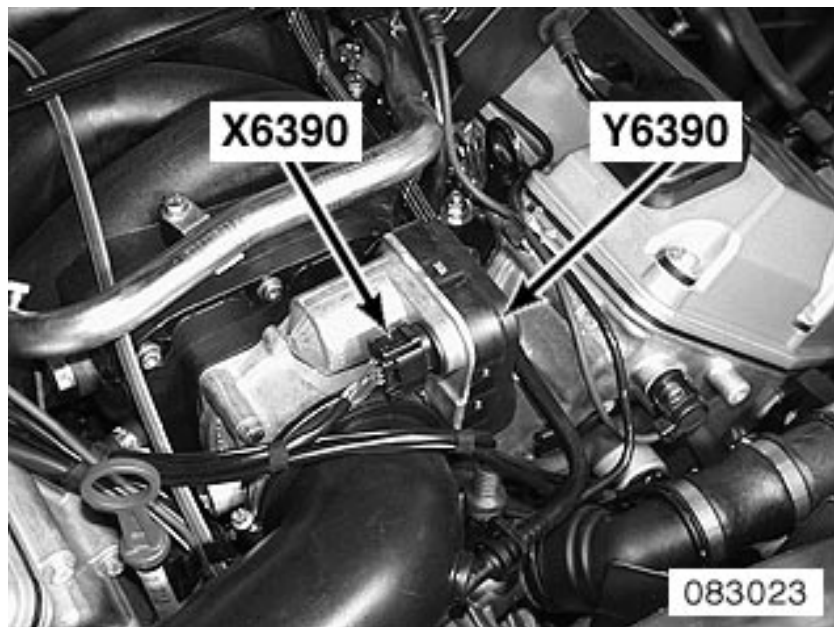

top center of engine

Y6390

Electric throttle actuator

X6390

Component connector (6-pin, Black), Electric throttle actuator

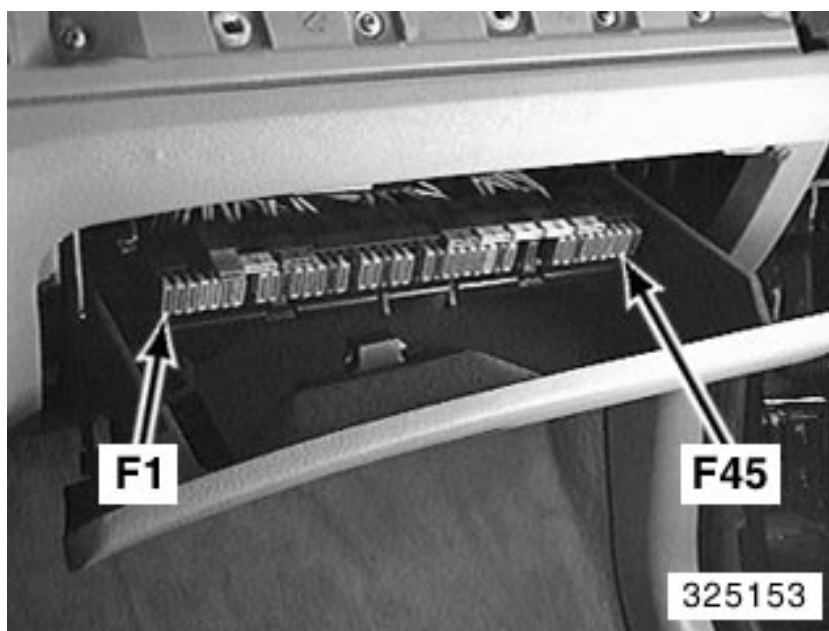

in glove box top

F1	Fuses F1 to F45
F45	Fuses F1 to F45

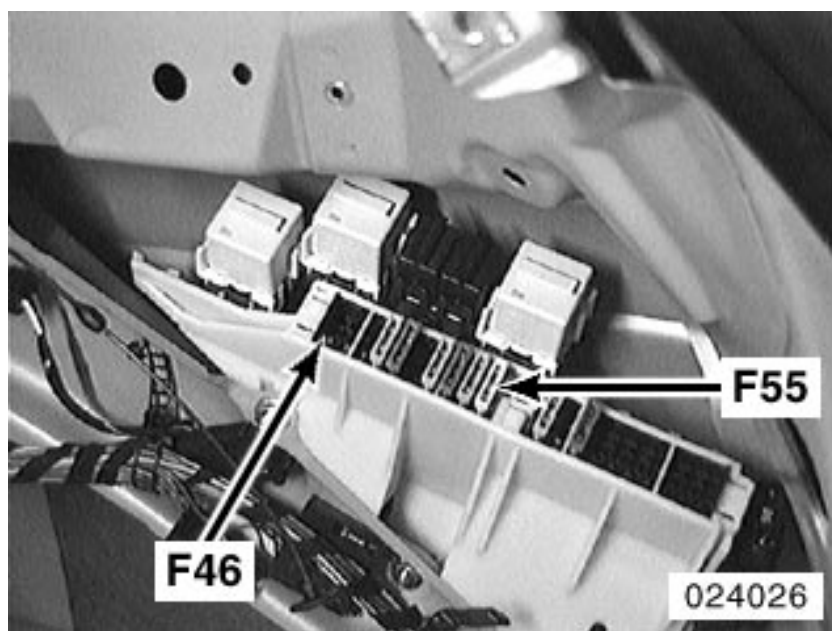

in rear RH side of luggage compartment behind trim panel

F46	Fuses F46 to F55
F55	Fuses F46 to F55

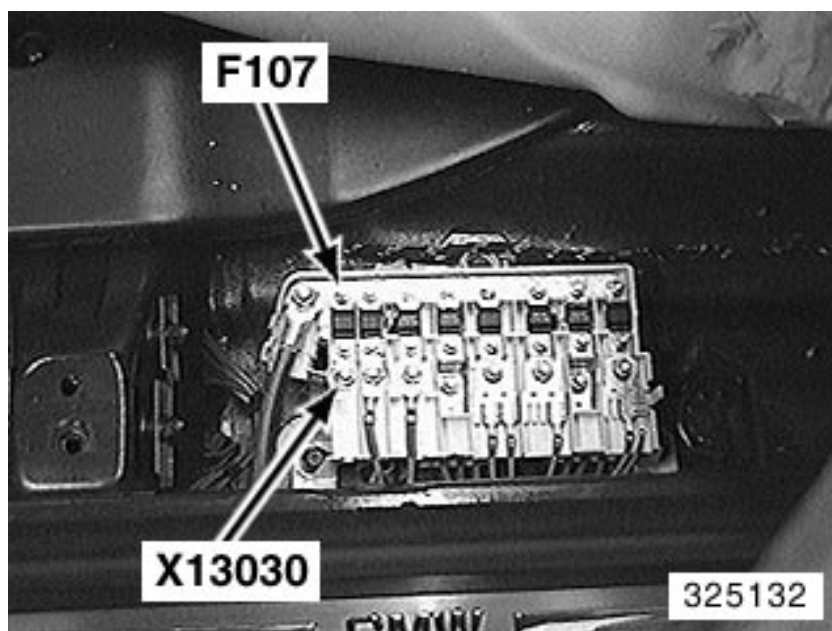

RH side of RH footwell under carpet

F107

Fuse F107

X13030

Cable shoe Fuse F107 voltage supply

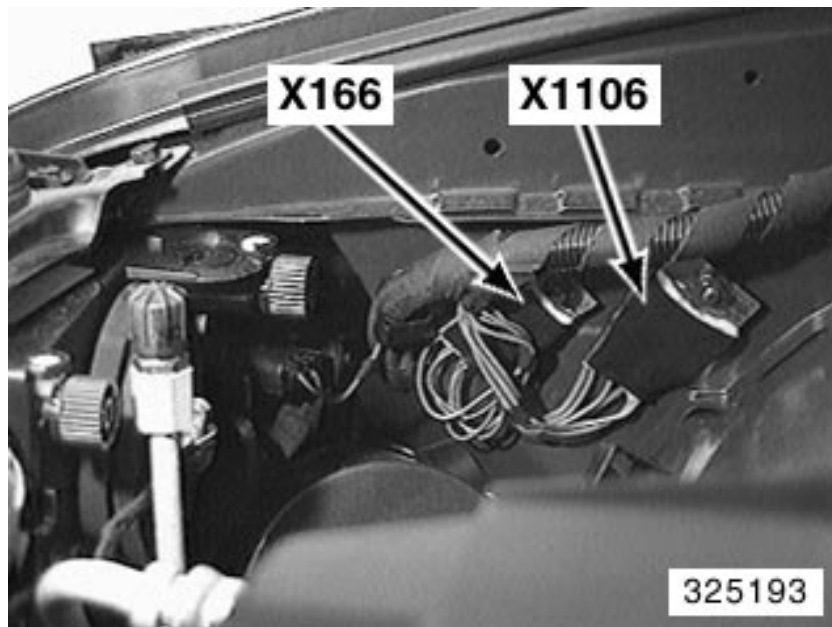

front RH side of engine compartment

X1106

Cable shoe Ground

X166

Cable shoe Ground



below RH side of dash driver's side footwell

X217

Splice Ground

X265

Splice Oil pressure

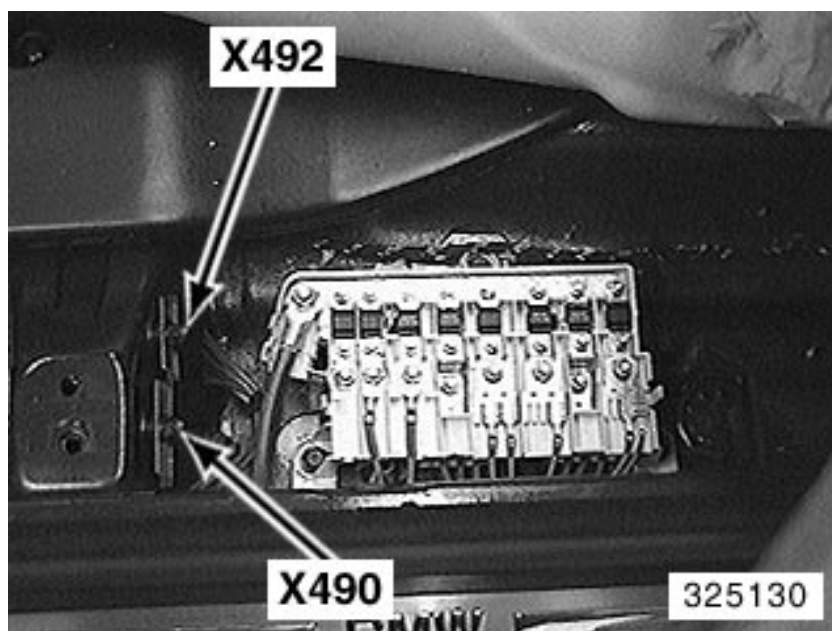

RH side of RH footwell under carpet

X490

Cable shoe Ground

X492

Cable shoe Ground

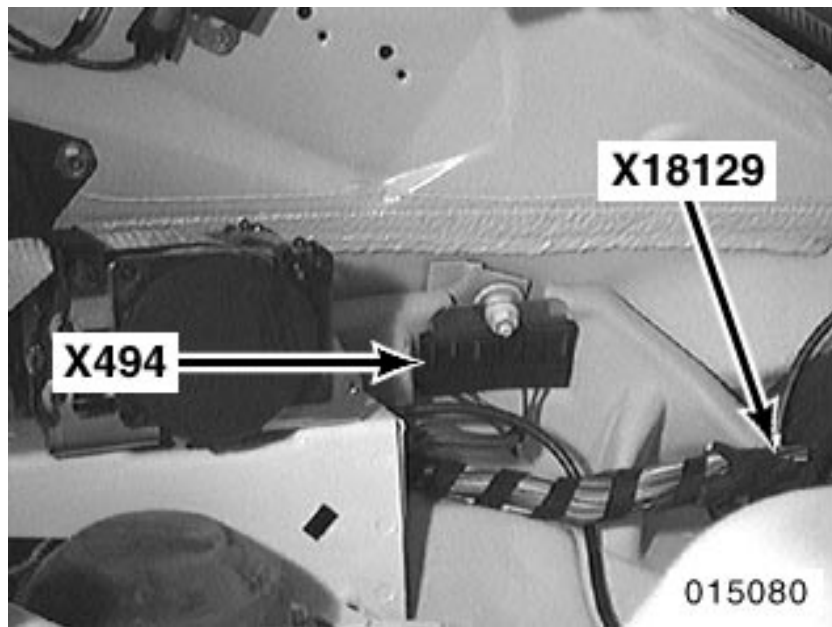

under rear window shelf right

X494	Cable shoe Ground
X18129	Splice Terminal 30



rear RH side of engine compartment

X6452

Cable shoe Ground point

X6453

Cable shoe Ground point

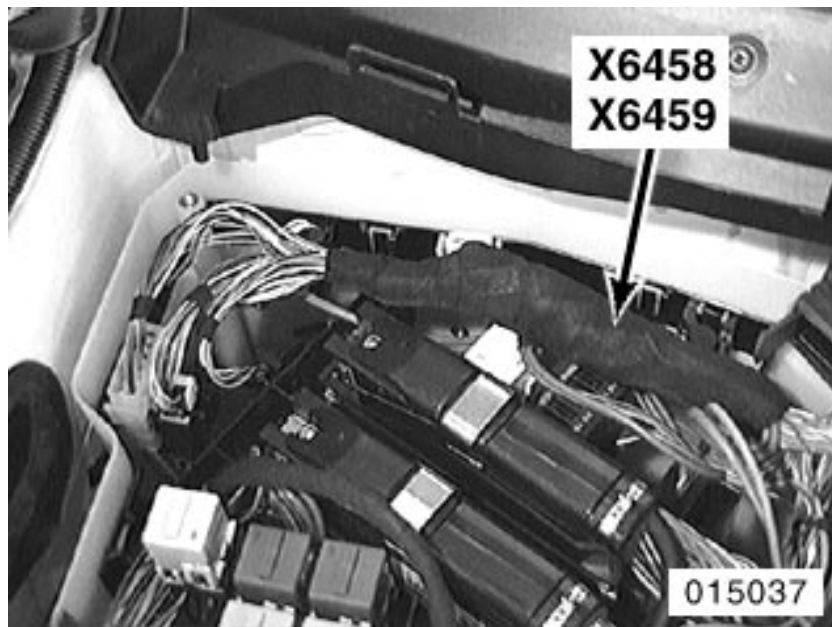

rear RH side of engine compartment in E-Box

X6458

Splice Ground connector, power

X6459

Splice Ground connector, electronics

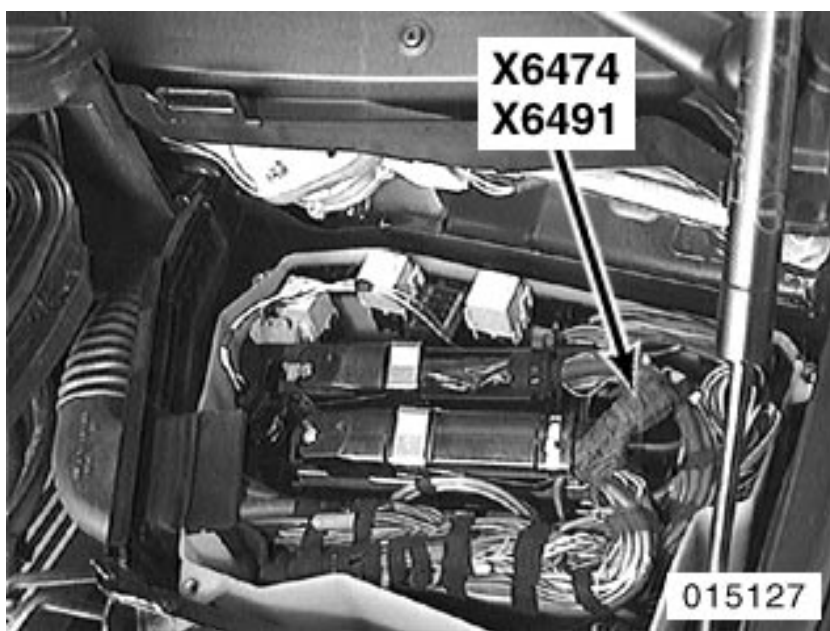

rear LH side of engine compartment in E-Box

X6474

Splice Terminal 31

X6491

Splice Shield

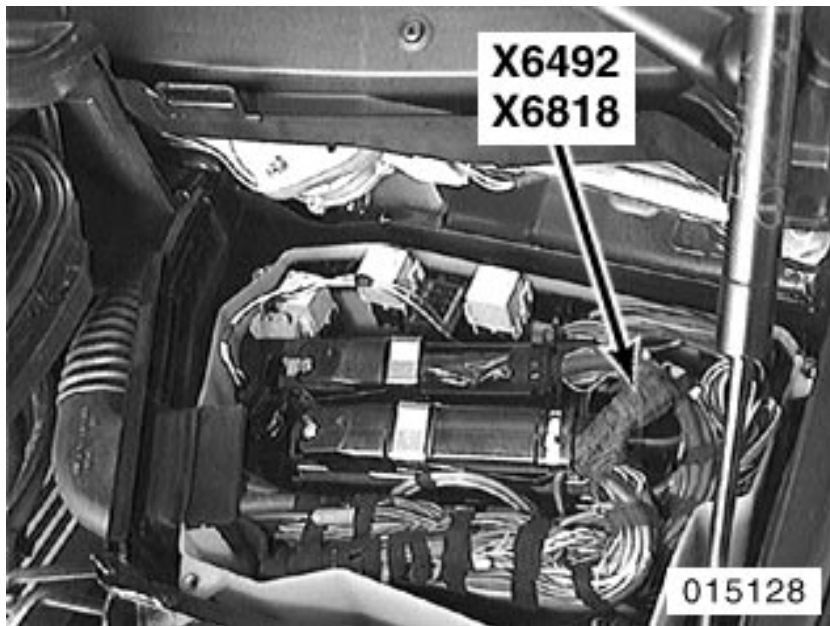

rear LH side of engine compartment in E-Box

X6492

Splice Shield

X6818

Splice Terminal 87

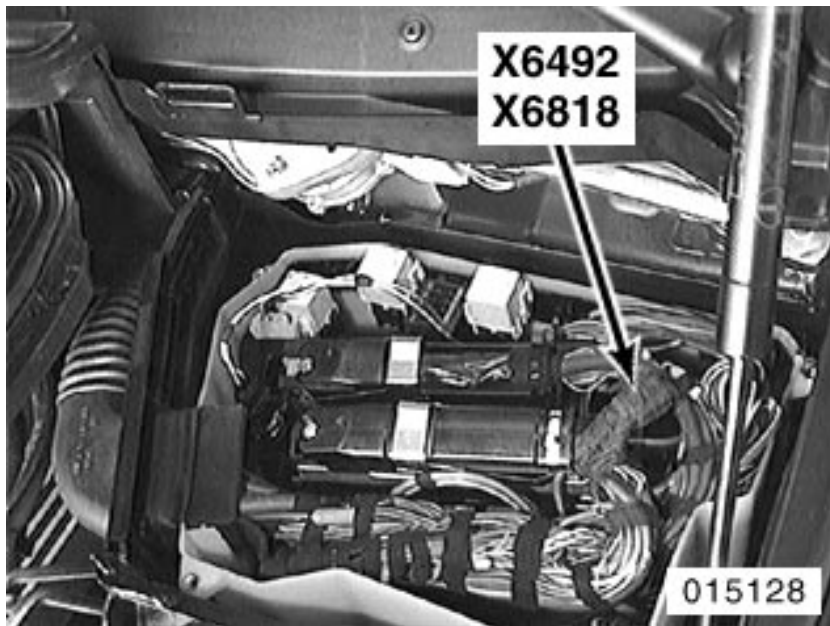

rear LH side of engine compartment in E-Box

X6492

Splice Shield

X6818

Splice Terminal 87

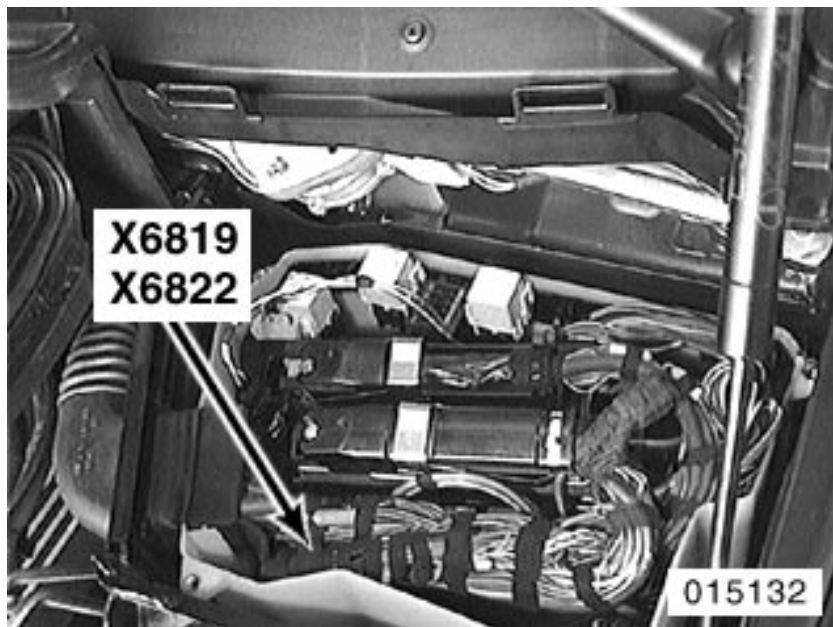

rear LH side of engine compartment in E-Box

X6819

Splice Terminal 50

X6822

Splice Terminal 87

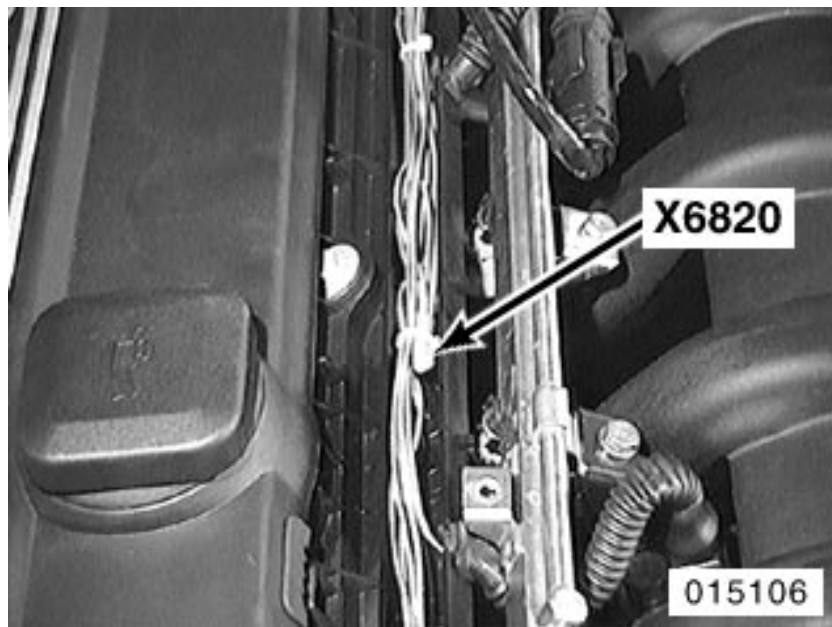

in injector valve rail

X6820

Splice Terminal 87

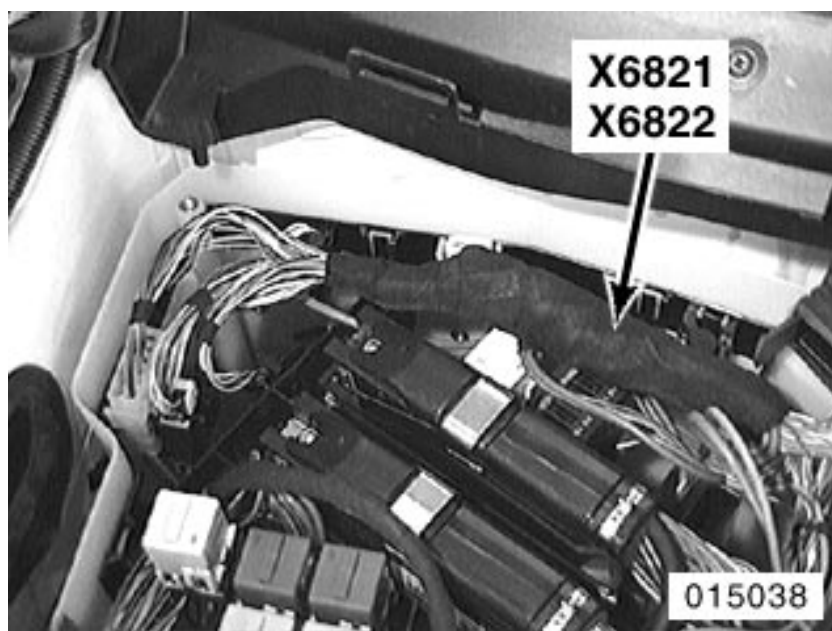

rear RH side of engine compartment in E-Box

X6821

Splice Terminal 87

X6822

Splice Terminal 87



driver's side footwell

X19527

Component connector (16-pin, Black), OBDII plug

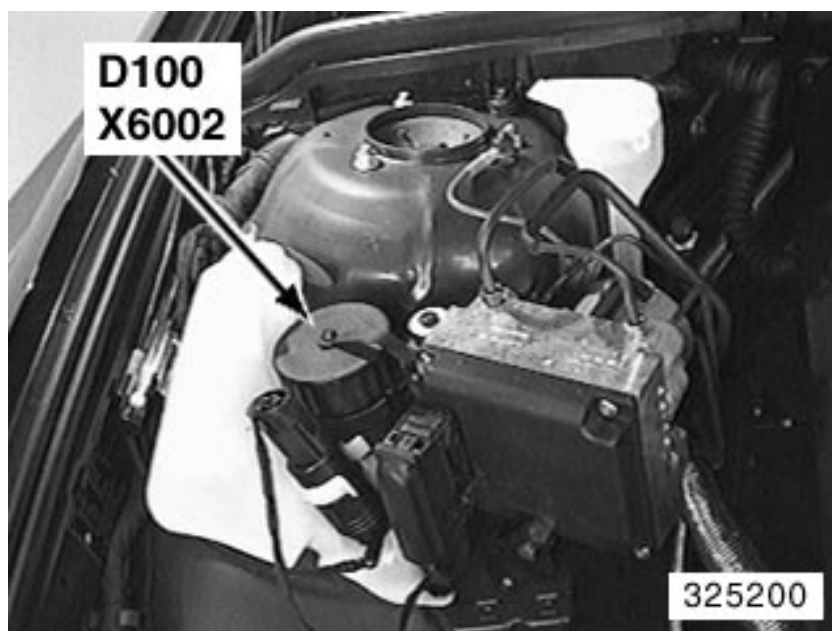

rear LH side of engine compartment

D100

Data link connector

X6002

Component connector (20 -pin, Black), Data link connector

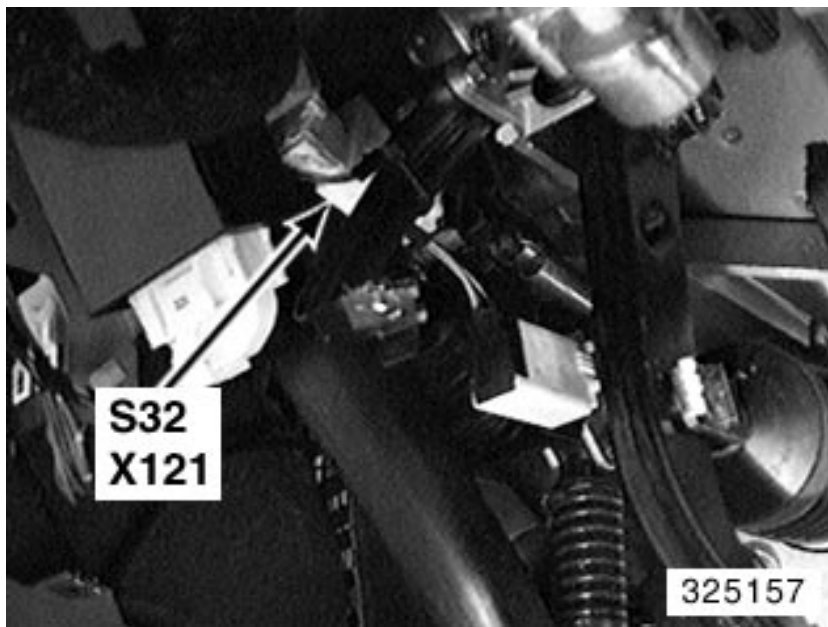

below LH side of dash

S32

Clutch pedal position switch

X121

Component connector (2 -pin, White), Clutch pedal position switch